

# **Report on Roller-Compacted Mass Concrete**

Reported by ACI Committee 207



**American Concrete Institute®**  
*Advancing concrete knowledge*



First Printing  
July 2011

American Concrete Institute®  
*Advancing concrete knowledge*

## Report on Roller-Compacted Mass Concrete

Copyright by the American Concrete Institute, Farmington Hills, MI. All rights reserved. This material may not be reproduced or copied, in whole or part, in any printed, mechanical, electronic, film, or other distribution and storage media, without the written consent of ACI.

The technical committees responsible for ACI committee reports and standards strive to avoid ambiguities, omissions, and errors in these documents. In spite of these efforts, the users of ACI documents occasionally find information or requirements that may be subject to more than one interpretation or may be incomplete or incorrect. Users who have suggestions for the improvement of ACI documents are requested to contact ACI via the errata website at [www.concrete.org/committees/errata.asp](http://www.concrete.org/committees/errata.asp). Proper use of this document includes periodically checking for errata for the most up-to-date revisions.

ACI committee documents are intended for the use of individuals who are competent to evaluate the significance and limitations of its content and recommendations and who will accept responsibility for the application of the material it contains. Individuals who use this publication in any way assume all risk and accept total responsibility for the application and use of this information.

All information in this publication is provided “as is” without warranty of any kind, either express or implied, including but not limited to, the implied warranties of merchantability, fitness for a particular purpose or non-infringement.

ACI and its members disclaim liability for damages of any kind, including any special, indirect, incidental, or consequential damages, including without limitation, lost revenues or lost profits, which may result from the use of this publication.

It is the responsibility of the user of this document to establish health and safety practices appropriate to the specific circumstances involved with its use. ACI does not make any representations with regard to health and safety issues and the use of this document. The user must determine the applicability of all regulatory limitations before applying the document and must comply with all applicable laws and regulations, including but not limited to, United States Occupational Safety and Health Administration (OSHA) health and safety standards.

**Order information:** ACI documents are available in print, by download, on CD-ROM, through electronic subscription, or reprint and may be obtained by contacting ACI.

Most ACI standards and committee reports are gathered together in the annually revised *ACI Manual of Concrete Practice* (MCP).

**American Concrete Institute**  
**38800 Country Club Drive**  
**Farmington Hills, MI 48331**  
**U.S.A.**

**Phone: 248-848-3700**  
**Fax: 248-848-3701**

**[www.concrete.org](http://www.concrete.org)**

ISBN 978-0-87031-277-9

# Report on Roller-Compacted Mass Concrete

Reported by ACI Committee 207

Timothy P. Dolen  
Chair

Jeffrey C. Allen	Teck L. Chua	David E. Kiefer	Henry B. Prenger
Terrence E. Arnold	Barry D. Fehl	Gary R. Mass	Ernest K. Schrader
Randall P. Bass	John W. Gajda	Tibor J. Pataky	Stephen B. Tatro
Anthony A. Bombich	Rodney E. Holderbaum	Jonathan L. Poole	Michael A. Whisonant

Note: ACI Committee 207 would like to acknowledge Tim Dolen and Nate Tarbox for their significant contributions to the document.

### Consulting members

Eric J. Ditchey	William F. Kepler
Brian A. Forbes	Tom W. Read*
Richard A. Kaden	

\*Deceased

*Roller-compacted concrete (RCC) is a concrete of no-slump consistency in its unhardened state that is typically transported, placed, and compacted using earth and rockfill construction equipment. This report includes the use of RCC in structures where measures should be taken to cope with the generation of heat from hydration of the cementitious materials and attendant volume change to minimize cracking. Material mixture proportioning, properties, design considerations, construction, and quality control are covered.*

*The materials, processes, quality control measures, and inspections described in this document should be tested, monitored, or performed as applicable only by individuals holding the appropriate ACI certifications or equivalent.*

**Keywords:** admixtures; aggregates; air entrainment; compacting; compressive strength; conveying; creep properties; curing; lift joints; mixture proportioning; monolith joints; placing; shear properties; vibration; workability.

ACI Committee Reports, Guides, Manuals, and Commentaries are intended for guidance in planning, designing, executing, and inspecting construction. This document is intended for the use of individuals who are competent to evaluate the significance and limitations of its content and recommendations and who will accept responsibility for the application of the material it contains. The American Concrete Institute disclaims any and all responsibility for the stated principles. The Institute shall not be liable for any loss or damage arising therefrom.

Reference to this document shall not be made in contract documents. If items found in this document are desired by the Architect/Engineer to be a part of the contract documents, they shall be restated in mandatory language for incorporation by the Architect/Engineer.

## Chapter 1—Introduction, p. 2

- 1.1—General
- 1.2—What is roller-compacted concrete?
- 1.3—History
- 1.4—Advantages and disadvantages
- 1.5—Performance of RCC dams

## Chapter 2—Notation and definitions, p. 9

- 2.1—Notation
- 2.2—Definitions

## Chapter 3—Materials and mixture proportioning for roller-compacted concrete, p. 9

- 3.1—General
- 3.2—Materials
- 3.3—Mixture proportioning considerations
- 3.4—Mixture proportioning methods
- 3.5—Laboratory trial mixtures
- 3.6—Field adjustments

## Chapter 4—Properties of hardened roller-compacted concrete, p. 19

- 4.1—General
- 4.2—Strength

ACI 207.5R-11 supersedes ACI 207.5R-99 and was adopted and published July 2011. Copyright © 2011, American Concrete Institute.

All rights reserved including rights of reproduction and use in any form or by any means, including the making of copies by any photo process, or by electronic or mechanical device, printed, written, or oral, or recording for sound or visual reproduction or for use in any knowledge or retrieval system or device, unless permission in writing is obtained from the copyright proprietors.

- 4.3—Elastic properties
- 4.4—Dynamic properties
- 4.5—Creep
- 4.6—Volume change
- 4.7—Thermal properties
- 4.8—Tensile strain capacity
- 4.9—Permeability
- 4.10—Durability
- 4.11—Density

## Chapter 5—Design of roller-compacted concrete dams, p. 27

- 5.1—General
- 5.2—Foundation
- 5.3—Dam section considerations
- 5.4—Stress and stability analyses
- 5.5—Temperature studies and control
- 5.6—Contraction joints and cracks
- 5.7—Galleries and drainage
- 5.8—Facing design and seepage control
- 5.9—Spillways, aprons, and stilling basins
- 5.10—Outlet works

## Chapter 6—Construction of roller-compacted concrete dams, p. 39

- 6.1—General
- 6.2—Aggregate production and batching and mixing plant location
- 6.3—Batching and mixing
- 6.4—Transporting and placing
- 6.5—Compaction
- 6.6—Lift joints
- 6.7—Contraction joints
- 6.8—Forms and facings
- 6.9—Curing and protection from weather
- 6.10—Galleries and drainage

## Chapter 7—Quality control of roller-compacted concrete, p. 56

- 7.1—General
- 7.2—Activities before RCC placement
- 7.3—Activities during RCC placement
- 7.4—Activities after RCC placement

## Chapter 8—References, p. 66

- 8.1—Referenced standards and reports
- 8.2—Cited references

### CHAPTER 1—INTRODUCTION

#### 1.1—General

Roller-compacted concrete (RCC) is probably the most important development in concrete dam technology in the past quarter century. The use of RCC has allowed many new dams to become economically feasible due to the reduced cost realized from the rapid construction method. It also has provided design engineers with an opportunity to economically rehabilitate existing concrete dams that have problems with stability and need buttressing in addition to improving existing embankment dams with inadequate spillway



*Fig. 1.1—RCC compaction with dual-drum, vibrating roller (Serra do Facão Dam, Brazil, 2008).*

capacity by providing a means by which they can be safely overtopped. RCC has allowed new embankment dams to optimize spillway capacity in over-the-embankment-type emergency spillways (Hansen 1992).

This document summarizes the current state of the art for design and construction of RCC in mass concrete applications. It is intended to guide the reader through developments in RCC technology, including materials, mixture proportioning, properties, design considerations, construction, and quality control and testing. Although this report deals primarily with mass placements, RCC is also used for pavements (refer to ACI 325.10R) and for dam stability improvement and as embankment dam slope protection (United States Society on Dams 2003).

#### 1.2—What is roller-compacted concrete?

ACI Concrete Terminology (2010) defines roller-compacted concrete (RCC) as “concrete compacted by roller compaction; concrete that, in its unhardened state, will support a roller while being compacted.” RCC is usually mixed using high-capacity continuous mixing or batching equipment, delivered with trucks or conveyors, and spread with bulldozers in layers prior to compaction with vibratory rollers (Fig. 1.1). Because of RCC’s zero-slump consistency, subsequent lifts can be placed immediately after compaction of the previous lift. RCC can use a broader range of materials than conventional concrete, and derives its strength and durability from a mixture philosophy that relies on using just enough paste volume to fill the aggregate voids and no more water content than what is needed for proper workability.

#### 1.3—History

The rapid worldwide acceptance of RCC is a result of economics and of RCC’s successful performance. A bibliography of dams constructed is available from the International Commission on Large Dams. Other listings of dams constructed can be obtained from the United States Society on Dams (2003) and from the U.S. Army Corps of Engineers (USACE), EM 1110-2-2006 (USACE 2000). During the 1960s and 1970s, applications of RCC materials led to the development of RCC in engineered concrete structures. In the 1960s, a high-production no-slump mixture that could be

spread with bulldozers was used at Alpe Gere Dam in Italy (*Engineering News Record* 1964; Gentile 1964) and at Manicougan I in Canada (Wallingford 1970). The mixtures were consolidated with groups of large internal vibrators mounted on backhoes or bulldozers.

Fast construction of gravity dams using earthmoving equipment, including large rollers for compaction, was suggested in 1965 as a viable approach to more economical dam construction (Humphreys et al. 1965). The fast construction method did not receive much attention until it was presented for the “optimum gravity dam” (Raphael 1971). The concept considered a section similar, to but with less volume than, the section of an embankment dam. During the 1970s, a number of projects including laboratory and design studies, test fills, field demonstrations, nonstructural uses, and emergency mass uses were accomplished and evaluated using RCC. These efforts formed a basis for the first RCC dams, which were constructed in the 1980s.

Notable contributions were made in 1972 and 1974 by the Tennessee Valley Authority (Cannon 1972, 1974). The U.S. Army Corps of Engineers conducted studies of RCC construction at the Waterways Experiment Station in 1973 (Tynes 1973) and at Lost Creek Dam in 1974 (Hall and Houghton 1974). The early work by the U.S. Army Corps of Engineers was in anticipation of construction of an optimum gravity dam for Zintel Canyon Dam (Sivley 1976). Zintel Canyon Dam construction was not funded at the time, but many of its concepts were carried over to Willow Creek Dam, which was completed in 1982 and became the first RCC dam in the U.S.

Developed initially for the core of Shihmen Dam in 1960, “rollcrete” was used for massive rehabilitation efforts at Tarbela Dam in Pakistan beginning in 1974 (Hansen and Reinhardt 1991). Workers placed 460,000 yd<sup>3</sup> (350,000 m<sup>3</sup>) of RCC at Tarbela Dam in 42 working days to replace rock and embankment materials for outlet tunnel repairs. Additional large volumes of RCC were used later in the 1970s to rehabilitate the auxiliary and service spillways at Tarbela Dam (Johnson and Chao 1979).

Dunstan (1978; 1981a,b) conducted extensive laboratory studies and field trials in the 1970s using high-paste RCC in the UK. Further studies were conducted in the UK and led to more refined developments in laboratory testing of RCC and construction methods, including horizontal slipformed facing for RCC dams (Dunstan 1981a,b).

Beginning in the late 1970s in Japan, the design and construction philosophy referred to as roller-compacted dam (RCD) was developed for construction of Shimajigawa Dam (Hirose and Yanagida 1981; Chugoku Regional Construction Bureau 1981). In the context of this report, both RCC and the material for RCD are considered the same. Shimajigawa Dam was completed in 1981, with approximately half of its total concrete (216,000 yd<sup>3</sup> [165,000 m<sup>3</sup>]) being RCC. The RCD method uses RCC for the interior of the dam with relatively thick (approximately 3 ft [1 m]) conventional mass-concrete zones at the upstream and downstream faces, the foundation, and the crest of the dam. Frequent joints (sometimes formed) are used with conventional waterstops



Fig. 1.2—Willow Creek Dam, OR. (USACE 1984).



Fig. 1.3—Shimajigawa Dam (Ministry of Construction 1984).

and drains. Also typical of RCD are thick lifts with delays after the placement of each lift to allow the RCC to cure and, subsequently, be thoroughly cleaned before placing the next lift. The RCD process results in a dam with conventional concrete appearance and behavior, but it requires additional cost and time compared with dams that have a higher percentage of RCC to total volume of concrete.

Willow Creek Dam (Schrader and Thayer 1982) (Fig. 1.2) and Shimajigawa Dam (Ministry of Construction 1984) (Fig. 1.3) are the principal structures that initiated the rapid acceptance of RCC dams. They are similar from the standpoint that they both used RCC, but they are dissimilar with regard to design, purpose, construction details, size, and cost (Schrader 1982). Willow Creek Dam was completed in 1982 and became operational in 1983. The 433,000 yd<sup>3</sup> (331,000 m<sup>3</sup>) flood control structure was the first major dam designed and constructed entirely of RCC. Willow Creek Dam also incorporated the use of precast concrete panels to form the upstream facing of the dam without transverse contraction joints (Schrader and McKinnon 1984).

Winchester Dam was the second RCC dam in the U.S. and was completed in 1983. The major contribution of the Winchester Dam was its use of a polyvinyl chloride (PVC) membrane at the upstream face as the primary method of providing watertightness for the dam (Hansen and Reinhardt 1991). The membrane was attached to the inside (RCC side) of the precast concrete panels. Once the panels were set, the

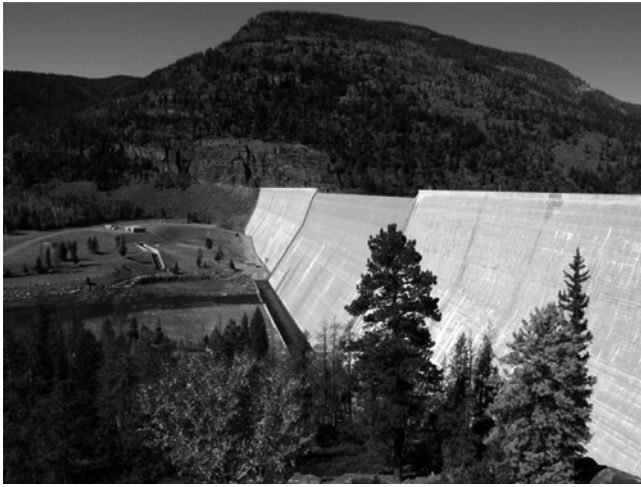

Fig. 1.4—Upper Stillwater Dam, UT. (Photo courtesy of the U.S. Bureau of Reclamation, 1988.)

membrane joints between abutting panels were sealed with a strip of membrane by heat welding. This facing system is referred to as the Winchester method (Sexton et al. 2010). The success of this facing system has contributed to designers specifying a membrane system (with or without precast panels) for 6% of all RCC dams worldwide. An alternative to attaching the membrane to precast panels is to place the membrane on the exposed face of the dam after RCC placement is concluded. As of 2009, the 318 ft (97 m) high Olivenhain Dam near San Diego was the only RCC dam in the U.S. that has the exposed membrane facing system. Wenquanpu Dam in China is the only RCC arch dam that has a membrane (exposed) facing system. Several dams that have a membrane facing system also have a geotextile/geocomposite layer between the RCC and the membrane to collect any leakage. By adding this drainage medium, designers can consider taking a reduction in uplift pressures at lift joints because the drainage medium collects any water that might bypass the membrane.

In the 1980s, the U.S. Bureau of Reclamation used concepts of high-paste RCC for the construction of Upper Stillwater Dam (Fig. 1.4) (Oliverson and Richardson 1984). Laboratory investigations and field trials were performed to demonstrate that an RCC placed with sufficient paste could provide bonding between successive layers without bedding concrete or mortar. Notable innovations at this structure included using a steep compound downstream slope (0.6 horizontal to 1.0 vertical (0.6H:1.0V) for the lower 215 ft (65 m) of the dam and 0.32 horizontal to 1.0 vertical for the upper 75 ft (23 m) and using 3 ft (0.9 m) high, horizontally-slipformed upstream and downstream facing elements as an outer skin of conventional low-slump, air-entrained concrete. The RCC mixture consisted of 70% Class F pozzolan by mass of cement plus pozzolan (Dolen et al. 1988).

In Australia, the Copperfield Dam was constructed in 1984, containing 183,000 yd<sup>3</sup> (140,000 m<sup>3</sup>) of RCC that was placed in 16 weeks. (Forbes 1985). It was designed with vertical monolith joints, RCC was placed directly against vertical forms for the upstream face, and a thin conventional

concrete facing of 12 in. (300 mm) was placed at the same time as the RCC to create a monolithic spillway facing. The dam experienced high velocity (100 ft/s [30 m/s]) spillway flows and was also constructed in a region with heavy rain seasons.

Other countries quickly started developing their own RCC projects that incorporated lessons learned from early applications. They also started developing new design details and construction methods. The Saco De Nova Olinda Dam was Brazil's first RCC dam, and was completed in 1986. This 184 ft (56 m) high dam used 180,000 yd<sup>3</sup> (138,000 m<sup>3</sup>) of RCC and was placed in 110 days. Brazil has constructed 36 RCC dams higher than 50 ft (15 m) (Andriolo 1998), including the 220 ft (67 m) high Salto Caxias Dam that has the largest hydroelectric generating capacity (6500 MW) of any RCC dam constructed to date. The design philosophy in Brazil is centered around using conventional concrete for the upstream facing, using little fly ash (only 2% of Brazil power comes from coal), using stone dust or crushed powder as a filter material (some cases have shown pozzolanic properties), and incorporating 8 to 12% fines in the RCC mixture.

Growth and acceptance of the RCC process increased in the late 1980s (Hansen and Reinhardt 1991). In 1983, there were only two RCC dams in the world. By the end of 2001, there were 264 large (greater than 50 ft [15 m] high) RCC dams in 37 countries. Thirty-three of these dams were greater than 300 ft (90 m) high, and were mainly located in China and Japan. The highest completed RCC gravity dam is the Longtan Dam in southern China, which is 715 ft (218 m) high. Dams are increasingly using larger volumes of RCC. The 1.6 mi (2.6 km) long Tha Dan Dam in Thailand has 6.45 million yd<sup>3</sup> (4.9 million m<sup>3</sup>) of RCC whereas the Longtan Dam in China has 6.5 million yd<sup>3</sup> (4.9 million m<sup>3</sup>). At the end of 2007, there were 74 completed RCC gravity dams in the U.S., ranging in height from 10 to 318 ft (3 to 97 m); 83 overtopping spillways of existing embankment dams; 12 uses of RCC for added support of existing concrete and masonry dams; and another 72 miscellaneous uses of RCC in water resources applications. Based on these statistics and the potential for using RCC to rehabilitate numerous existing dams that lack sufficient spillway capacity and/or suffer from structural deficiencies, the largest market for RCC in the U.S. may be in the rehabilitation of existing dams. In 2003, the United States Society on Dams published a comprehensive document emphasizing the practical aspects of RCC uses for dam rehabilitation. In addition to RCC mixture design and specifications, the document covers RCC for overtopping protection of embankment dams, dam stability improvement, spillways, dam raising, and seepage control. McDonald and Curtis (1997) summarized a wide variety of RCC applications in rehabilitation and replacement of hydraulic structures. The Taum Sauk replacement dam (Fig. 1.5) has 2.96 million yd<sup>3</sup> (2.25 million m<sup>3</sup>) of RCC.

A summary of RCC references is given in the 1994 U.S. Committee on Large Dams Annotated Bibliography (1994). References are also given by CHINCOLD and SPANCOLD, "Proceedings of the International Symposium on Roller

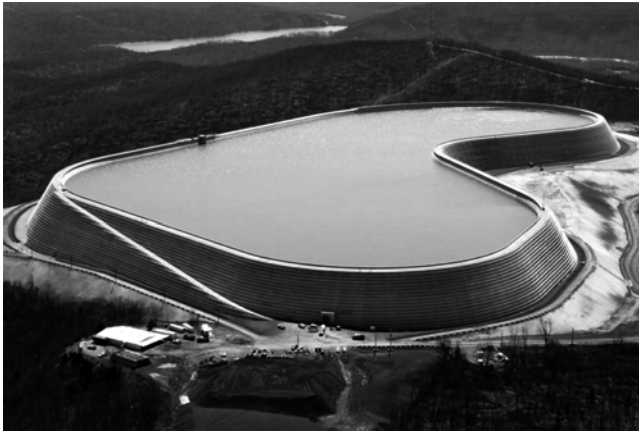

Fig. 1.5—Taum Sauk Dam, MO. (Photo Courtesy of ASI Constructors, Inc., 2007).

Compacted Concrete Dams,” Beijing, China, 1991; Santander, Spain, 1995; Chengdu, China, 1999; Madrid, Spain, 2003; and Gulyang, China, 2007.

**1.3.1 Production and delivery**—Many of the early-1980s dams successfully demonstrated the high production rates possible with RCC construction. Nearly 1.5 million yd<sup>3</sup> (1.1 million m<sup>3</sup>) of RCC were placed at Upper Stillwater Dam in 11 months of construction between 1985 and 1987 (McTavish 1988). The 150 ft (46 m) high Stagecoach Dam was constructed in only 37 calendar days of essentially continuous placing; it had an average rate of height advance of 4.1 ft/day (1.2 m/day) (Arnold and Johnson 1992). At Elk Creek Dam, RCC placing rates exceeded 12,000 yd<sup>3</sup>/day (9200 m<sup>3</sup>/day) (Hopman 1992).

For a short time, Olivenhain Dam (Fig. 1.6) held the world record for 1-day placement: 16,000 yd<sup>3</sup> (12,250 m<sup>3</sup>) was placed in a 19.5-hour day. It also had a maximum monthly placement of 287,790 yd<sup>3</sup> (220,025 m<sup>3</sup>) (Pauletto et al. 2003), and is only one of three RCC dams that had an average of over 130,000 yd<sup>3</sup> (100,000 m<sup>3</sup>) per month placement rate.

Placement rates have continued to increase for several reasons. Engineers understand that fast, uninterrupted placement of RCC generally leads to better overall quality, particularly at lift joints, and that minimizing obstructions to RCC placement leads to faster production rates. Contractors have improved on their means and methods of delivering the RCC to the placement area. At Willow Creek Dam, scrapers were used to bring the RCC from the mixing plant to the dam surface. On smaller lift areas, traffic on the lift surface becomes increasingly confined, and efficiency suffers. Beginning in 1984, conveyors began to deliver RCC from mixing plants to the lift surface. At Middle Fork Dam in Colorado, a series of stacker conveyors was used with a rock ladder to drop the RCC from the conveyor to the lift surface to minimize segregation (Parent et al. 1985). Similar setups using a variety of conveyors and drop chutes were subsequently used at Elk Creek, Upper Stillwater, Grindstone Canyon, Stagecoach, and Quail Creek Dams in the U.S. In all of these cases, haul vehicles were used to deliver RCC from the conveyor discharge above the lift surface to the active placement locations throughout the lift surface.



Fig. 1.6—Olivenhain Dam, CA. (Photo courtesy of San Diego County Water Authority, 2002.)



Fig. 1.7—Continuous all-conveyor placing, Miel Dam, Colombia. (Photo courtesy of INGETEC S.A., 2002).

Beginning in 1989, the benefit of conveyors was extended by using systems that could deliver RCC to essentially every location on the lift surface. At Marmot Dam near Sandy, OR, in 1989, conveyors were used to transport RCC from the mixing plant to a tower embedded in the dam (this dam was removed in 2007 to improve fish migration). A pivoting conveyor on top of the tower could deposit RCC at nearly any location on the dam lift surface. In 1992 at Siegrist Dam near Pine Grove, PA, the first crawler-placer was used to place RCC. This system included a mainline conveyor from the mixing plant to the upstream face of the dam, a conveyor mounted on the upstream face of the dam that was raised with the dam, a tripper conveyor that delivered RCC to the crawler placer, and the crawler placer that traveled across the lift surface. This system was subsequently used on several dams, including Spring Hollow Dam in Virginia in 1993 and at Meil I Dam in Colombia (Fig. 1.7).

Several dams have used a vacuum chute to transport the RCC down very steep abutments without segregation into trucks on the lift surface. At Shapai Dam in China, a high negative-pressure chute was used with a height of 238 ft (72.5 m). A variation of this type of system was used at the Platanovryssi Dam in Greece, and at the 508 ft (155 m) high Ralco Dam in Chile. At Ralco, RCC was conveyed down a

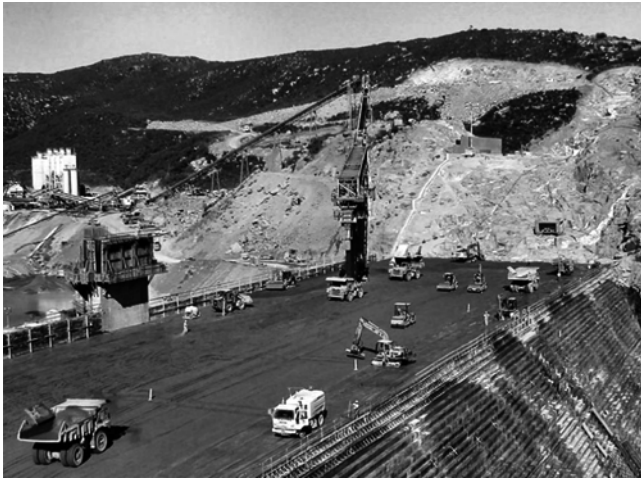

Fig. 1.8—Overview of conveyor transporting RCC to waiting trucks on dam surface, Olivenhain Dam, CA. (Photo courtesy of San Diego County Water Authority, 2002).

45-degree right abutment slope using an additional conveyor belt on top of the RCC to keep it from running down or spilling off the belt (Croquevielle et al. 2003). This system has supported a 10-day moving average production rate of 6860 yd<sup>3</sup> (5244 m<sup>3</sup>) per day with a monthly peak of 186,676 yd<sup>3</sup> (142,714 m<sup>3</sup>).

Since the early 1990s, a variety of portable conveyor systems have been used throughout the U.S. A popular setup, especially for smaller dams and spillways, uses conveyors on moving crawler-tractors or telescoping conveyors from trucks. These setups are situated off of the structure, minimizing lift surface traffic and facilitating construction of high-quality lift joints. Their portability makes them economical for small-volume projects where access by vehicles is impossible or less practical.

Many of the large production projects used off-road dump trucks as a major component of the delivery system. At Olivenhain Dam (Fig. 1.8) and Yeywa Dam, Myanmar, conveyors were used to transport RCC from the mixing plant to a fixed transfer point on the dam. Trucks were then used to transport RCC to various locations on the lift. This method is a popular method for large dams because of the relatively large work area available for equipment on the dam.

**1.3.2 Facing systems**—There are more than a dozen different facing systems for RCC gravity dams (Hansen 2001). The two most common systems are the conventional concrete facing that is placed concurrently with each RCC lift and RCC placed against conventional formwork using the grout-enriched RCC (GERCC) method. Another name associated with GERCC is grout-enriched vibratable RCC (GEVR) (Forbes 1999). GERCC is used for upstream and downstream facing of RCC dams. The first dam to use GERCC was Jiangya Dam in China. While the grout-enriched zone is generally limited to the facing or abutment contact zones, the location or sequence of grout placement is one of the biggest variations between users. Sometimes the grout is placed on top of the compacted RCC lift just before the next lift is placed. Other times, the grout is placed on top

of the uncompacted lift. In both cases, the RCC section with grout is vibrated using large immersion vibrators. The typical process consists of altering the composition of RCC by adding cementitious grout to the RCC mixture. The intent is to distribute the grout through the RCC by internal pneumatic vibrators, producing a mixture similar to conventional concrete. Other facing systems commonly used in RCC construction include stay-in-place precast panels with or without geomembranes, conventional and roller-compacted concrete with geomembranes, and slip-formed concrete.

Shapai Dam in China and Ghatghar Dam in India used GEVR for both upstream and downstream facing. Bolivia's first RCC dam, La Canada Dam at 170 ft (52 m) high, used GEVR. GERCC was used at Ralco Dam for facing and abutment treatment and for the gallery walls. The first significant uses of GERCC in the U.S. were at Olivenhain Dam, where it was used at the upstream face and the abutment contacts, and at Hickory Log Creek Dam, where it was used in the non-overflow steps.

The U.S. Army Corps of Engineers has a research program to study air-entrained RCC and GERCC for potential application in lock and guide walls where the RCC would be critically saturated and in a freezing-and-thawing environment. Early results have demonstrated that an air-entrained RCC face is resistant to freezing-and-thawing cycles, but producing a stable air-entrained grout and ensuring that the grout is uniformly distributed throughout the GERCC in the field is difficult and still undergoing further study (McDonald 2002).

**1.3.3 Lift configurations**—Most RCC dams have horizontal level RCC lift surfaces. Several dams have a cross-fall slope in the upstream direction to increase the resistance to sliding. Miel II Dam used a 1 on 100 cross-fall slope (Marulanda et al. 1992), and Saluda Dam in Columbia, SC, completed in 2004, used a 1 on 30 cross-fall slope. Due to high rainfall at Ralco Dam, Chile, RCC lifts were placed at 1% downstream cross fall to improve drainage (Croquevielle et al. 2003).

For the taller RCC dams being built in particularly high seismic regions, lift joint strength and impermeability are crucial design parameters. To maximize lift joint strength properties, successive RCC lifts should be placed before the initial set of the previous lift has occurred. If no retarder is used in the RCC mixture, most mixtures will have an initial set time of 1 to 3 hours; for large dams, it may take between 15 and 30 hours to cover one lift. The Ta Sang Dam in Myanmar will have 32.3 million yd<sup>2</sup> (2700 hectares) of total lift joint surface area, an average of over 70,000 yd<sup>2</sup> (5.8 hectares) per lift. With the normal horizontal lift construction method, it would take many hours to place one lift. The sloping layer placement method was developed in China as a method to improve lift quality, maximize strength properties, and minimize the use of bedding mortars. It was first used at the 430 ft (131 m) high Jiangya Dam, followed by the Fenghe No. 2 Dam, Mianhuatan Dam, and Dachaoshan Dam, which are all located in China (Forbes 1999). Tannur Dam in Jordan and portions of Lajeado Dam in Brazil have also used the sloping layer method. At Jiangya Dam, the RCC was initially placed on a 1:10 slope in the cross canyon direction



to an eventual height of 10 ft (3 m). This process proceeded across the entire length of the dam until the dam was brought up by 10 ft (3 m). The process was again repeated for another 10 ft (3 m). The contractor eventually changed to a 1:20 slope.

The first application for the sloping layer method in the U.S. was at Table Rock Dam in Missouri, where RCC was placed to support a large gated conventional concrete spillway.

**1.3.4 Design sections**—The vast majority of RCC gravity dams have vertical upstream faces and sloping downstream faces. The downstream slopes have ranged from 1H:1V to 0.8H:1V, with a few exceptions. Upper Stillwater Dam has a compound downstream slope. The lower two-thirds of the face was at a 0.6H:1V, and the upper section was at 0.32H:1V. At Olivenhain Dam, the slope was placed at a 0.8H:1V, but transitioned on a 232 ft (70 m) radius to near vertical on the upper quarter of the slope. The radius concept was used to reduce any stress concentrations at an abrupt change in section slope.

Spain has more than 24 RCC dams, and all are straight gravity dams with the exception of one arch-gravity dam. Several of these dams have a sloping or battered upstream face to provide the necessary stability. Santa Eugenia Dam has a 0.05H to 1V upstream face, and Val Dam has a 0.2H to 1V upstream slope transitioning to a vertical upstream slope approximately halfway up the dam. The first RCC arch gravity dams were constructed in South Africa by the Department of Water Affairs and Forestry for the Knellport and Wolwedans Dams (Fig. 1.9) (Hollingworth et al. 1988). China has built several thin RCC arch dams, starting with Wenquanpu Dam at 208 ft (63.5 m) high, and followed by the 358 ft (109 m) high Shi Menzi Dam. The Shapai Dam is the highest arch dam to date at 423 ft (129 m) high with a crest length of 820 ft (250 m). It is a three-centered single curvature arch dam containing 477,000 yd<sup>3</sup> (365,000 m<sup>3</sup>) of RCC.

**1.3.5 Extreme climates**—RCC dams are commonly located in regions where extreme weather conditions are prevalent. At La Presa Ralco Dam (Fig. 1.10), the annual rainfall averages 120 in. (3000 mm), with temperatures ranging between 50 to 100°F (12 to 39°C) (Moreno 2003). During normal RCC placement, the mixture had a consistency time of 15 to 18 seconds, but during wet periods, it was increased to 20 to 25 seconds, and the bedding mortar, which was used on every lift, had some water removed. The bedding mixture placement was limited to no more than 20 ft (6 m) in advance of the RCC placement. With these mixture modifications, rainfall rates of up to approximately 0.1 in. (3 mm) per hour could be accommodated. During the cold periods, the mixing water was heated to 140°F (60°C), and extra thick insulation blankets were used. The Bio Bio River Dam had a minimum flow rate of 3000 ft<sup>3</sup>/s (90 m<sup>3</sup>/s) and a recorded maximum flow rate of 120,000 ft<sup>3</sup>/s (3390 m<sup>3</sup>/s). The original cofferdam failed, and the RCC-modified replacement overtopped on several occasions. The main dam overtopped when the cofferdam was overtopped or its spillway operated.

The first RCC dam in Iran was Jahgin Dam, which was 256 ft (78 m) high. During the summer, the ambient air temperature would reach 122°F (50°C). Because of this,



Fig. 1.9—Wolwedans Dam, South Africa (Hollingworth et al. 1988).

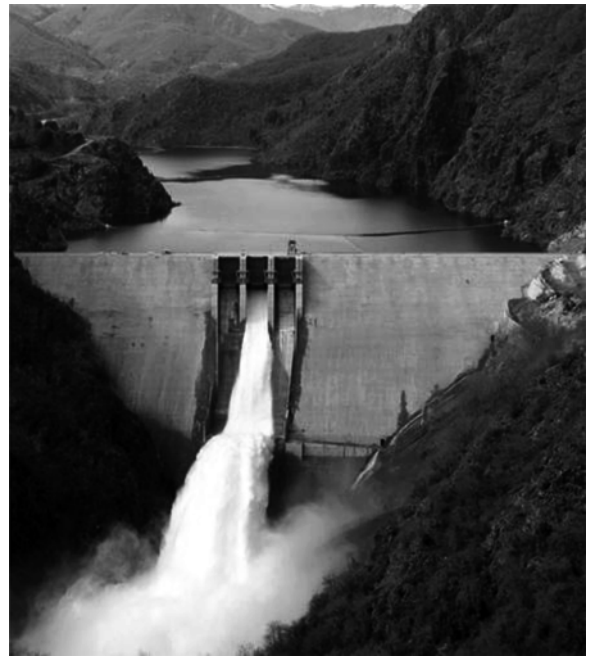

Fig. 1.10—Le Presa Ralco Dam, Chile. (Photo courtesy of B. Forbes and E. Warren, 2003).

RCC production was limited to the time of the year between November to May. Maximum allowable ambient placing temperature was restricted to 73°F (23°C) (Azari et al. 2003). The first RCC dam in India, Ghatghar Dam, had air temperatures as hot as 104°F (40°C) and a monsoon period that lasted 4 to 5 months (Shelke et al. 2006).

**1.3.6 Mixture proportions**—The mixture proportions used throughout the world have varied widely (Portland Cement Association 2002). Many of the first-generation dams used lean dry mixtures, such as Middle Fork Dam in the U.S., which used a cement content of 112 lb/yd<sup>3</sup> (66 kg/m<sup>3</sup>) and no ash, and Galesville Dam (also in the U.S.), which used 89 lb/yd<sup>3</sup> (53 kg/m<sup>3</sup>) of cement and 86 lb/yd<sup>3</sup> (51 kg/m<sup>3</sup>) of fly ash. The Upper Stillwater Dam is an exception, with 134 lb/yd<sup>3</sup> (79 kg/m<sup>3</sup>) of cement and 292 lb/yd<sup>3</sup> (172 kg/m<sup>3</sup>) of fly ash. Most dams constructed in the U.S. today average more than 200 lb/yd<sup>3</sup> (118 kg/m<sup>3</sup>) of cementitious materials.

Urugua Dam in Argentina has a cement content of only 102 lb/yd<sup>3</sup> (60 kg/m<sup>3</sup>) with no pozzolans. Rock fines from a basalt quarry were used to provide adequate paste in the dry



Fig. 1.11—Le Presa Ralco Dam, Chile, overtopping during construction. (Photo courtesy of B. Forbes and E. Warren, 2003).

consistency mixture. The trend in Spain is the use of high paste mixtures of  $250 \text{ lb/yd}^3$  ( $150 \text{ kg/m}^3$ ) cementitious materials, with fly ash making up to 70% of the cementitious materials. In Brazil, fly ash is not readily available, so stone dust or crushed powder is used as a filler. Some of these fillers have shown pozzolanic properties. In Jordan, three RCC dams were designed during the same period, with Tannur Dam having a high paste, Wala Dam having a medium paste, and Mujib Dam having a lean consistency.

#### 1.4—Advantages and disadvantages

The advantages in RCC dam construction are extensive, but there are also some disadvantages that should be recognized. Some of the advantages are primarily realized with certain types of mixtures, structural designs, production methods, weather, or other conditions. Likewise, some disadvantages apply only to particular site conditions and designs. Each RCC project should be thoroughly evaluated based on technical merit and cost.

The main advantages are reduced cost, time of construction, and lower spillway costs. Another advantage of RCC dams is that the technology can be implemented rapidly. For emergency projects such as the Kerrville Pounding Dam, RCC was used to rapidly build a new dam downstream of an embankment dam that was in imminent danger of failure due to overtopping (*Engineering News Record* 1986). RCC was also used to quickly construct Concepcion Dam in Honduras after declaration of a national water supply emergency (Giovagnoli et al. 1991). Following the devastating fires at Los Alamos, NM, Pajarito Dam was built as a design/build project. This 130 ft (40 m) high dam was designed and constructed in less than 6 months. When compared with embankment-type dams, RCC usually gains an advantage when spillway and river diversion requirements are large, where suitable foundation rock is close to the surface, and when suitable aggregates are available near the site. Another advantage is reduced cofferdam requirements because, once started, an RCC dam can be overtopped with minimal impact, and the height of the RCC dam can quickly exceed the height of the cofferdam. The 4th Street RCC dam in Fort

Worth, TX, replaced an earth dam that overtopped twice and failed each time during construction before a concrete shell could be completed. Following the second failure, an RCC gravity dam was constructed. During the 16 days of RCC placement, the project was overtopped during a flash flood, but sustained no damage or construction delay. Other projects that overtopped during construction include Big Haynes Dam and Tie Hack Dam in the U.S. and Le Presa Ralco Dam in Chile (Fig. 1.11).

Although it is almost routine for efficiently designed RCC dams to be the least costly alternative when compared with other types of dams, there are conditions that may make RCC more costly. RCC may not be appropriate when aggregate material is not reasonably available, the foundation rock is of poor quality or not close to the surface, or where foundation conditions can lead to excessive differential settlement. Sometimes it is difficult for an RCC dam to compete with an earthfill dam unless the dam is on a large drainage basin. For large inflows, many earthfill dams require a separate large reinforced conventional concrete spillway that can cost more than the dam itself. In these situations, RCC dams can be competitive because flows can then be passed over the dam in a spillway section.

#### 1.5—Performance of RCC dams

Because RCC technology is relatively new and documentation of structural performance is not readily available, the performance record for RCC dams is somewhat limited. The rapid acceptance of this approach to dam construction, however, has resulted in many completed projects with a vast range of details, sizes, and locations. This allows both generalized and detailed comments to be made about performance to date.

Performance involves design and construction in addition to strength and operation of the completed structure. Completed RCC dams are performing their intended purpose quite well. Each type of RCC material and design tends to have advantages and disadvantages, and performs better in some areas than in others. This includes seepage, in-place strength, and properties including lift joints, cracking, and durability.

In 1988, there were eight RCC dams in the U.S., one in Brazil, and one in Australia; other RCC dams were being completed or put into operation. At that time, any RCC dam had been in operation a maximum of only 5 years, with most of the dams having been just recently completed. The major performance aspects of each project, including cost, schedule, strength, thermal stress and cracking, and seepage were reported (ASCE 1988).

Only 15 years later, there were more than 250 completed RCC dams in approximately 39 countries. There are many types of RCC, many approaches to design, and many ways to detail various aspects of the work. No single approach is best for all situations. Each project should be evaluated to determine the best options and overall approach. Data are needed to evaluate the overall performance of RCC dams in different environments. Important data need to include lift line bonding properties, seepage and the performance of various facing methods, long-term strength performance,

dynamic properties and performance under seismic loadings, durability in freezing-and-thawing environments, and the overall structural performance of high RCC dams.

## CHAPTER 2—NOTATION AND DEFINITIONS

### 2.1—Notation

$A$	=	area of cross section
$c$	=	unit cohesion
$N$	=	component of confining force normal to the sliding surface
$T$	=	driving force parallel to the sliding surface
$U$	=	uplift force acting on cross section
$\phi$	=	angle of sliding friction

### 2.2—Definitions

**concrete, roller-compacted**—concrete compacted by roller compaction; concrete that, in its unhardened state, will support a roller while being compacted.

**dam, arch**—a structure resisting the pressure of impounded water by an arch principle, especially a dam having in plan the form of a single arch abutted by natural rock formations.

**dam, gravity**—a structure resisting the pressure of impounded water through its own weight.

**gallery**—a tunnel constructed through a dam used for construction access, drainage systems, and inspection activities.

**grout-enriched roller-compacted concrete (GERCC)**—RCC that is enriched by adding a fluid grout of cement and water to the uncompacted RCC and consolidated with immersion vibrators (also referred to as grout-enriched vibrated roller-compacted concrete).

**joint, lift**—interface between two successive lifts.

## CHAPTER 3—MATERIALS AND MIXTURE PROPORTIONING FOR ROLLER-COMPACTED CONCRETE

### 3.1—General

Mixture proportioning methods and objectives for RCC differ from those of conventional concrete. RCC should maintain a consistency that will support a vibratory roller and haul vehicles, and also be suitable for compaction by a vibratory roller or other external methods. The aggregate grading and paste content are critical parts of mixture proportioning. Specific testing procedures and evaluation methods have been developed that are unique to RCC technology.

This chapter contains discussion of materials selection criteria and considerations in determining the method of mixture proportioning for mass RCC placements. It presents several alternative methods of mixture proportioning and contains references to various projects. Requirements are usually site-specific, considering the performance criteria of the structure and are based on the designer's approach, design criteria, and desired degree of product control. Regardless of the material specifications selected or mixture-proportioning method, the testing and evaluation of laboratory trial batches are essential to verify the fresh and hardened properties of the concrete.

The cementitious material content for RCC dams has varied over a broad range, from 100 lb/yd<sup>3</sup> (59 kg/m<sup>3</sup>) to

more than 500 lb/yd<sup>3</sup> (297 kg/m<sup>3</sup>). At one end of the spectrum, the 3 in. (75 mm) nominal maximum size aggregate (NMSA) interior mixture at Willow Creek Dam contained 112 lb/yd<sup>3</sup> (60.5 kg/m<sup>3</sup>) of cementitious material. The mixture, which contained 80 lb/yd<sup>3</sup> (47.5 kg/m<sup>3</sup>) of cement plus 32 lb/yd<sup>3</sup> (19.0 kg/m<sup>3</sup>) of fly ash, averaged 2620 psi (18.2 MPa) compressive strength at 1 year (USACE 1984). In comparison, the 2 in. (50 mm) NMSA interior mixture at Upper Stillwater Dam contained 424 lb/yd<sup>3</sup> (251.6 kg/m<sup>3</sup>) of cementitious material, consisting of 134 lb/yd<sup>3</sup> (79.5 kg/m<sup>3</sup>) of cement plus 290 lb/yd<sup>3</sup> (172.0 kg/m<sup>3</sup>) of fly ash, and averaged 6170 psi (42.6 MPa) at 1 year (Crow et al. 1984). Many RCC projects have used a cementitious materials content between 175 and 300 lb/yd<sup>3</sup> (105 and 180 kg/m<sup>3</sup>) and produced an average compressive strength between 2000 to 3000 psi (14 and 21 MPa) at an age of 90 days to 1 year. Mixture proportions for some dams are presented in Table 3.1.

An essential element in the proportioning of RCC for dams is the volume of paste. The paste volume should fill or nearly fill aggregate voids and produce a compactible, dense concrete mixture. The paste volume should also be sufficient to produce bond and watertightness at the horizontal lift joints when the mixture is placed and compacted quickly on a reasonably fresh joint. Mixtures containing a low quantity of cementitious materials may require added quantities of nonplastic fines to supplement the paste fraction in filling aggregate voids.

Certain economic benefits can be achieved by reducing the processing requirements on aggregates; the normal size separations; and the separate handling, stockpiling, and batching of each size range. The designer, however, should recognize that reducing or changing the normal requirements for concrete aggregates should be weighed against greater variation in the properties of the RCC that is produced, and should be accounted for by a more conservative RCC design assumption.

### 3.2—Materials

A wide range of materials have been used in the production of RCC. Much of the guidance on materials provided in ACI 207.1R may be applied to RCC. The material constraints of gravity RCC structures are often less demanding; thus, other materials quality options and subsequent performance characteristics are possible. The designer, as always, should evaluate the actual materials for the specific project and the proportions under consideration, design the structure accordingly, and provide appropriate construction specifications.

#### 3.2.1 Cementitious materials

**3.2.1.1 Portland cement**—RCC can be made with any of the basic types of portland cement such as found in ASTM C150/C150M, C595/C595M, C1157/C1157M, and applicable AASHTO standards, or other international standards. ASTM C150/C150M cements are specified by both chemical and physical requirements. For mass applications, cements with a lower heat generation are desirable to control or reduce thermal cracking. Lower heat generation is achieved primarily by decreasing the percentage of tricalcium aluminate (C<sub>3</sub>A) and the ratio of tricalcium silicate to dicalcium silicate

Table 3.1—Mixture proportions of some roller-compacted concrete (RCC) dams

Dam/ project	Mixture type/ID	Year	NMSA, in. (mm)	Air, %	Water	Cement	Pozzolan	Fine aggregate	Coarse aggregate	Density, lb/ yd <sup>3</sup> (kg/ m <sup>3</sup> )	Air-entrained admixture, oz/yd <sup>3</sup> (cc/m <sup>3</sup> )	Water-reducing admixture, oz/yd <sup>3</sup> (cc/m <sup>3</sup> )
					Quantities, lb/yd <sup>3</sup> (kg/m <sup>3</sup> )							
Al Wehdah	70C60F	2006	2.0 (50)	2.0	211 (25)	118 (70)	101 (60)	1530 (910)	2300 (1365)	4260 (2530)	22 (13)	—
Al Wehdah	60C60F	2006	2.0 (50)	2.0	211 (25)	101 (60)	101 (60)	1530 (910)	2310 (1370)	4255 (2525)	22 (13)	—
Camp Dyer	RCC1	1994	1.5 (37.5)	3.6	151 (90)	139 (82)	137 (81)	1264 (750)	2265 (1344)	3956 (2347)	7 (4)	4 (2)
Concepcion	152C	1990	3 (75)	0.5	157 (93)	152 (90)	0	1371 (813)	2057 (1220)	3737 (2217)	—	—
Cuchillo Negro	130C100P	1991	3 (75)	—	228 (135)	130 (77)	100 (59)	1591 (944)	2045 (1213)	4094 (2429)	—	—
Galesville	RCC1	1985	3 (75)	—	190 (113)	89 (53)	86 (51)	1310 (777)	2560 (1519)	4235 (2513)	—	—
	RCC2	1985	3 (75)	—	190 (113)	110 (65)	115 (68)	1290 (765)	2520 (1495)	4225 (2513)	—	—
Middle Fork	112C	1984	3 (75)	—	160 (95)	112 (66)	0	1152 (683)	2138 (1268)	3562 (2113)	—	—
Santa Cruz	RCCAEA	1989	2 (50)	2.3	170 (101)	128 (76)	127 (75)	1227 (728)	2301 (1365)	3953 (2345)	7 (4)	3 (2)
Siegrist	80C80P	1992	1.5 (37.5)	1	162 (96)	80 (47)	80 (47)	1922 (1140)	2050 (1216)	4294 (2548)	—	—
	90C70P	1992	1.5 (37.5)	1	162 (96)	90 (53)	70 (42)	1923 (1141)	2052 (1217)	4297 (2549)	—	—
	100C70P	1992	1.5 (37.5)	1	162 (96)	100 (59)	70 (42)	1920 (1139)	2048 (1215)	4300 (2551)	—	—
Stacey Spillway	210C105P	1989	1.5 (37.5)	—	259 (154)	210 (125)	105 (62)	3500 (2076)	—	—	—	—
Stagecoach	120C130P	1988	2 (50)	—	233 (138)	120 (71)	130 (77)	156 (686)	2459 (1459)	4098 (2431)	—	—
Upper Stillwater	RCCA85	1985	2 (50)	1.5	159 (94)	134 (79)	291 (173)	1228 (729)	2177 (1292)	3989 (2367)	—	12 (7)
	RCCB85	1985	2 (50)	1.5	150 (89)	159 (94)	349 (207)	1171 (695)	2178 (1292)	4007 (2377)	—	20 (12)
	RCCA	1986	2 (50)	1.5	167 (99)	134 (79)	292 (173)	1149 (682)	2218 (1316)	3960 (2349)	—	16 (9)
	RCCB	1986	2 (50)	1.5	168 (100)	157 (93)	347 (206)	1148 (682)	2131 (1264)	3952 (2345)	—	21 (12)
Urugua-I	101C	1988	3 (75)	—	169 (100)	101 (60)	0	2102 (1247)	2187 (1297)	4559 (2705)	—	—
Victoria	113C112P	1991	2 (50)	—	180 (107)	113 (67)	112 (66)	1365 (810)	2537 (1505)	4307 (2555)	—	—
Willow Creek	175C	1982	3 (75)	1.2	185 (110)	175 (104)	0	1108 (657)	2794 (1958)	4262 (2529)	—	—
	175C80P	1982	3 (75)	1.2	185 (110)	175 (104)	80 (47)	1097 (645)	2739 (1625)	4266 (2531)	—	—
	80C32P	1982	3 (75)	1.2	180 (107)	80 (47)	32 (19)	1123 (666)	2833 (1681)	4248 (2520)	—	—
	315C135P	1982	1.5 (37.5)	1.2	184 (109)	315 (187)	135 (80)	1390 (825)	2086 (1238)	4110 (2438)	—	—
Zintel Canyon	125CA	1992	2.5 (63)	4.5	170 (101)	125 (74)	0	1519 (901)	2288 (1357)	4102 (2434)	18 (11)	18 (11)
	125CNA	1992	2.5 (63)	1.4	188 (112)	125 (74)	0	1586 (941)	2371 (1407)	4270 (2533)	—	18 (11)
	300CA	1992	2.5 (63)	—	171 (101)	300 (178)	0	1348 (800)	2388 (1417)	4207 (2496)	36 (21)	42 (25)

(C<sub>3</sub>S to C<sub>2</sub>S). Higher heat generation may require decreased joint spacing for crack control. ASTM C150/C150M cement with optional heat-of-hydration limits, Type V (sulfate-resistant), and ASTM C595/C595M Type IP (portland-pozzolan cement) and Type IS (portland blast-furnace slag cement) can decrease heat generation. Strength development for these cements is usually slower than for the standard Type I (general use) cement at early ages, but higher strengths than RCC produced with Type I cement are ultimately produced.

Heat generation due to hydration of the cement is typically controlled by use of lower heat-of-hydration cements, use of less cement, and replacement of a portion of the cement with pozzolan or a combination of these. Reduction of peak concrete temperature may be achieved by other methods, such as reduced placement temperatures. The selection of cement type should consider economics of cement procurement. For small- and medium-sized projects, it may not be cost effective to specify a low-heat cement that is not locally available. The availability of cement types varies regionally and over time. Manufacturers in the U.S. are producing fewer cement types (less specialty types such as Type IV and Type V) than in the past. Consequently, the selection of cement type for mass concrete placements needs to be thoroughly researched and confirmed before selecting cement for a laboratory mixture proportioning program and specifying for a project. Due to the high production capability

of RCC, special attention may be required to ensure a continuous supply of cement to the project.

**3.2.1.2 Pozzolans**—The selection of a pozzolan suitable for RCC should be based on its conformance with ASTM C618. Pozzolans meeting the specifications of ASTM C618 for Class C, Class F, and Class N have been successfully used in RCC mixtures. Class F and Class N pozzolans are preferred because they normally contribute less heat of hydration than Class C and have greater sulfate resistance. For Class C pozzolans, more attention may be needed with regard to set time, sulfate resistance, and free lime content. The use of pozzolan will depend on required material performance as well as on its cost and availability at each project.

Pozzolan in RCC mixtures may serve one or more of the following purposes: 1) as a partial replacement for cement to reduce heat generation; 2) as a partial replacement for cement to reduce cost; and 3) as an additive to provide supplemental fines for mixture workability and paste volume. The rate of cement replacement may vary from none to 80% by mass. RCC mixtures with a high cementitious material content often use larger amounts of pozzolan to replace portland cement to reduce the internal temperature rise that would otherwise be generated and consequently reduce thermal stresses.

In RCC mixtures with a low cement content, pozzolans have been used to ensure an adequate amount of paste for

filling aggregate voids and coating aggregate particles. While the pozzolan enhances the paste volume of these mixtures, it may not enhance the long-term strength development if the pozzolan has a low reactivity.

Class F pozzolan, especially at cool temperatures, generally delays the initial set of RCC mixtures, contributing to low early strength but extending the working life of the freshly compacted lift joint. In high pozzolan-content RCC mixtures, the beneficial reduction in early temperature rise may be partially offset by continued temperature rise after 28 days. Mixtures with high pozzolan content can experience considerable additional heat rise from 30 to 90 days after placement compared with 100% cement mixtures. The fineness and reactivity of Class F pozzolan is critical for strength performance. The 1-year compressive strength of high-pozzolan RCC mixtures at Upper Stillwater Dam decreased 12% when the percentage retained on the No. 325 sieve increased from approximately 24 to 38% (Dolen 2003). The optimum percentage of pozzolan should thus be determined by testing with the job materials.

### 3.2.2 Aggregates

**3.2.2.1 General quality issues**—The selection of aggregates and the control of aggregate properties and grading are important factors influencing the quality and uniformity of RCC production. Aggregates similar to those used in conventional concrete and aggregates that do not meet the normal standards or requirements for conventional concrete have both been successfully used in RCC dam construction (Gaekel and Schrader 1992). The use of manufactured coarse aggregate (crushed stone) has been found to reduce the tendency for segregation as compared with rounded gravels.

Marginal aggregates are those aggregates that do not meet traditional standards, such as ASTM C33/C33M. Limits on physical requirements and on deleterious materials for aggregates to be used in RCC for a specific application should be established before construction based on required concrete performance and demonstrated field and laboratory evaluations. The majority of RCC projects have been constructed with aggregates meeting all of the ASTM C33/C33M requirements, with the exception of an increased amount of fines passing the No. 200 (75  $\mu$ m) sieve. The mineralogy of fines (for example, fines from aggregates such as limestone and granite) has a significant effect on water demand and workability of RCC. The allowable amount of fines in RCC mixtures for mass placements should therefore be determined based on the most readily available and most economical aggregate that produces RCC meeting the project structural requirements.

Aggregates of marginal quality have been used in RCC on some projects because they were close to the site and thereby the most economical source available. The design of the structure should accommodate any change in performance that may result. On some projects, mixtures that used aggregates of lower physical strength produced RCC with satisfactory creep rates, elastic moduli, and tensile strain capacity. These properties are desirable for mass concrete applications where lower concrete strength can be tolerated.

If practical, lower-quality aggregates are best used in the interior of dams where they can be encapsulated by higher-quality concrete, especially in freezing-and-thawing areas.

RCC can provide a modulus of elasticity equal to or greater than that of a conventional concrete of equal compressive strength. For preliminary design studies, USACE ETL 110-2-343 (USACE 1993) recommends assuming the modulus of elasticity to be equal to  $57,000(f'_c)^{1/2}$  increased by 15% for seismic load conditions and reduced by 33% for long-term loading conditions where creep effects are important. A basic objective in proportioning any concrete is to incorporate the maximum amount of aggregate and minimum amount of water into a workable mixture, thereby reducing the cementitious material quantity and reducing consequent volume change of the concrete. This objective is accomplished by using a well-graded aggregate with the largest maximum size that is practical for placement. The proper combination of materials should result in a mixture that achieves the desired properties with adequate paste and a minimum cementitious content. However, in RCC mixtures, the potential for segregation and the means of compaction should also be primary considerations in selecting the maximum size of aggregate. Although early projects in the U.S. used a 3 in. (75 mm) NMSA, a 2 in. (50 mm) NMSA or smaller is less prone to segregation and is becoming more widely used.

The combined aggregate gradation should be selected to minimize segregation. The key to controlling segregation and providing a good compactible mixture is having a grading that is consistent and contains more material passing the No. 4 (4.75 mm) sieve than typical in conventional concrete of similar NMSA. Table 3.2 provides typical combined aggregate grading for various projects.

In conventional concrete, the presence of any significant quantity of flat and elongated particles is usually undesirable. RCC mixtures, however, appear to be less affected by flat and elongated particles than conventional concrete mixtures because vibratory compaction provides more energy than traditional consolidation. Field tests with 40% flat and elongated particles on any sieve and an average less than 30%, as determined by ASTM D4791 with a ratio of 1:5, have had no significant problems. The U.S. Army Corps of Engineers currently has a limit of 25% on the allowable content of flat and elongated particles in any size group (USACE 1994b).

**3.2.2.2 Coarse aggregate**—The selection of NMSA should be based on the need to reduce cementitious material requirements, control segregation, economize aggregate production, and facilitate compaction. Most RCC projects have used a NMSA of 1-1/2 to 3 in. (37.5 to 75 mm). The U.S. Bureau of Reclamation presently limits the NMSA to 2 in. (50 mm) and requires a minimum of 50% crushed aggregate in mass RCC. There has typically not been enough material cost savings from using aggregate sizes larger than 3 in. (75 mm) to offset the added batching cost and cost of controlling the increased segregation problems associated with the larger aggregates. Coarse aggregate size has little effect on compaction when the thickness of the placement

**Table 3.2—Combined aggregate gradings for RCC from various projects in U.S.**

Sieve size	Willow Creek	Upper Stillwater	Christian Siegrist	Zintel Canyon	Stagecoach	Elk Creek
4 in. (100 mm)	—	—	—	—	—	—
3 in. (75 mm)	100	—	—	—	—	100
2.5 in. (62 mm)	—	—	—	100	—	96
2 in. (50 mm)	90	100	—	98	100	86
1.5 in. (37.5 mm)	80	95	100	91	95	76
1 in. (25 mm)	62	—	99	77	82	64
3/4 in. (19 mm)	54	66	91	70	69	58
3/8 in. (9.5 mm)	42	45	60	50	52	51
No. 4 (4.75 mm)	30	35	49	39	40	41
No. 8 (2.36 mm)	23	26	38	25	32	34
No. 16 (1.18 mm)	17	21	23	18	25	31
No. 30 (0.60 mm)	13	17	14	15	15	21
No. 50 (0.30 mm)	9	10	10	12	10	15
No. 100 (0.15 mm)	7	2	6	11	8	10
No. 200 (75 $\mu$ m)	5	0	5	9	5	7
C + P, lb/yd <sup>3</sup> (kg/m <sup>3</sup> )	80 + 32 (47 + 19)	134 + 291 (80 + 173)	100 + 70 (59 + 42)	125 + 0 (74 + 0)	120 + 130 (71 + 77)	118 + 56 (70 + 33)
Total fines*, %	20	21	19	21	—	21
Workability	Poor	Excellent	Excellent	Excellent	Good	Excellent

\*Total fines = all materials in full mixture with particle size smaller than No. 200 (75  $\mu$ m) sieve.

layers is more than three times the NMSA, segregation is adequately controlled, and large vibratory rollers are used.

Grading of coarse aggregate usually follows ASTM C33/C33M size designations. Where close control of grading of coarse aggregate and RCC production are desired, size separations should follow normal concrete practice, as recommended in ACI 304R. Cost savings can be realized by combining two or more size ranges such as ASTM C33/C33M size designations 357 or 467 for 2 in. to No. 4 (50 to 4.75 mm) and 1-1/2 in. to No. 4 (37.5 to 4.75 mm), respectively. Note that as the size range increases, it becomes increasingly difficult to avoid segregation of the larger particles during stockpiling and handling of this aggregate. Aggregates for RCC have been in a single stockpile or have been separated into as many as five aggregate sizes. Some projects simply use a coarse-aggregate and a fine-aggregate stockpile. Other projects have blended products from multiple stockpiles that are not strictly coarse and fine fractions. Pinebrook Dam in Colorado used two base gravel type gradations—one commercially produced and the other produced from site materials. More important than the stockpile split is the resulting combined gradation and the ability to produce a consistent, workable mixture that can be mixed, placed, and compacted. An advantage for coarse aggregate separation arises for projects in hot climates or designs needing precooled aggregates to meet temperature requirements. Fine aggregates or aggregates with fine contents are difficult to cool with chilled water or air-blast methods.

The design engineer should weigh the potential cost savings in a reduction in the number of stockpiles and separate handling and weighing facilities against the potential for increased variation in aggregate grading and its impact on uniform placement and compaction.

RCC mixtures for overtopping protection for embankment dams frequently use a NMSA of 1 in. (25 mm) because the

concrete section is less massive and there are normally no significant temperature concerns. Some designers have used locally available aggregate road base material with grading requirements similar to that contained in ASTM D2940/D2940M. Because the volume of concrete required is normally not substantial, the RCC mixture can be obtained from locally available commercial concrete suppliers.

**3.2.2.3 Fine aggregate**—The grading of fine aggregate strongly influences paste requirements and compactibility of RCC. It also affects water and cementitious material requirements needed to fill the aggregate voids and coat the aggregate particles.

For those mixtures with a sufficient cementitious materials content and paste volume, ASTM C33/C33M fine-aggregate grading can be used. ASTM graded fine aggregates are necessary if an air-entraining admixture is used in RCC.

**3.2.2.4 Fines**—The primary role of supplemental fines (material passing the No. 200 [75  $\mu$ m] sieve) is to lower the volume of voids in fine aggregates without significantly increasing the water demand of the RCC mixture. In low cementitious-materials or low paste-content mixtures, supplemental fines are usually required to fill all the aggregate void spaces. Depending on the volume of cementitious material and the NMSA, the required total minus No. 200 (75  $\mu$ m) fines may be as much as 10% of the total aggregate mass, with most mixtures using approximately 3 to 8%. Characteristics of the fines and fines content will affect the relative compactibility of the RCC mixture, and can influence the number of passes of a vibratory roller required for full compaction of a given layer thickness. Regardless of whether it is accomplished by adding aggregate fines, cement, pozzolan, or combination of these, most compactible RCC mixtures contain approximately 8 to 12% total solids finer than the No. 200 (75  $\mu$ m) sieve by volume, or 12 to 16% by mass. This is illustrated in Table 3.2. The fines fill

aggregate void space, provide a compactible consistency, help control segregation, and decrease permeability. Including aggregate fines in low cementitious-paste mixtures allows reductions in the cementitious materials content, provided that they fill voids that would otherwise be filled with cementitious paste in the aggregates. Excessive additions of aggregate fines after the aggregate voids are filled are harmful to the RCC mixture because of decreased workability, increased water demand, and subsequent strength loss.

When adding aggregate fines to a mixture, another consideration is the nature of the fines. Crusher fines and silty material are usually acceptable. Clay fines, which are also called plastic fines, can cause an increase in water demand and a loss of strength, and produce a sticky mixture that is difficult to mix, transport, and compact. Fines, especially clay fines, may coat the surfaces of coarse aggregates and reduce the paste-aggregate bond and reducing strength potential. This problem can be avoided by washing the coarse aggregates either during production or before batching.

**3.2.3 Chemical admixtures**—Chemical admixtures have been used in RCC mixtures to change the setting properties and, in some cases, to affect a change in water content. The effectiveness of chemical admixtures may depend on the workability of the mixture, the aggregate gradation, and the type of cementitious materials. Chemical admixtures in RCC are commonly used to retard the setting time to reduce cold joints for improving bond between successive lifts (Wenquan et al. 1997). ASTM C494/C494M Types A (water-reducing) and D (water-reducing and retarding) are the most commonly used chemical admixtures. Water-reducing admixtures, used at very high dosages, have been shown to reduce water demand, increase strength, retard set, and promote workability in some RCC mixtures (Hopman and Chambers 1988). As with conventional concrete, the presence of minus No. 200 (75  $\mu\text{m}$ ) fines in many RCC mixtures can impact the dosage rate required to be effective, particularly if the fines content is high or if they include clay. Admixtures should be evaluated with the actual RCC materials before being used in the field.

Air-entraining admixtures are not commonly used in RCC mixtures because of the difficulty in generating the voids of the proper size and distribution when the mixture has a no-slump consistency. Air-entrained RCC has been used on a production basis in China and the U.S. The freezing-and-thawing resistance of RCC is improved with entrained air (Dolen 1991). To entrain air in RCC, however, a Vebe consistency less than approximately 20 seconds is generally necessary, and the aggregates should be free from excessive fines. The dosage of air-entraining admixture has ranged from the normal manufacturers' dosage for clean aggregates to higher than normal for other mixtures.

Entrained air has an additional benefit as a means of improving the workability of the RCC, decreasing the paste volume, and decreasing the Vebe consistency. The total water content of air-entrained RCC can be reduced as much as 12% compared with the same non-air-entrained mixture (Dolen 2002).

In some instances, caution is necessary to avoid reducing the paste volume of air-entrained RCC to less than the minimum necessary to fill aggregate voids without air (refer to Table 3.2). This can cause segregation and difficulties in achieving complete compaction if the air is lost.

The costs of admixtures in RCC include the costs of the admixtures, the batching equipment costs, and the additional cost for quality-control testing. The dosage is normally by mass of cementitious materials, or sometimes by cement only. Unless an unusually high dosage is necessary, the cost of admixtures is similar or less than conventional concrete due to the low cementitious materials content of many RCC mixtures. The cost of batching admixtures ranges from no substantial cost for conventional batching plants to the cost of adding batching devices for continuous batching plants. To control air-entrained RCC, inspectors should perform the necessary air content tests and be able to discern if changes in density in the field (through nuclear density testing) are the result of changes in air content or changes in compaction.

### 3.3—Mixture proportioning considerations

Optimum RCC proportions consist of a balance between good material properties and acceptable workability for the placement methods. This includes minimizing segregation. In implementing a specific mixture-proportioning procedure, the following considerations regarding plastic and hardened properties should be addressed.

**3.3.1 Workability**—Sufficient workability is necessary to achieve compaction or consolidation of the mixture. Sufficient workability is also necessary to provide an acceptable appearance when RCC is to be compacted against forms. Workability is most affected by the paste portion of the mixture that includes cement, pozzolan, aggregate fines, water, and air. When there is sufficient paste to fill aggregate voids, workability of RCC mixtures is normally measured on a vibratory table with a Vebe apparatus (Fig. 3.1) in accordance with ASTM C1170. This test produces a Vebe time for the specific mixture and is used similar to the slump test for conventional concrete. RCC mixtures with Vebe consistency of 10 to 45 seconds have a workability sufficient for ease of compaction, uniform density from top to bottom of the lift, bonding with previously placed lifts, and for support of compaction equipment. RCC mixtures, however, have been proportioned with a wide range of workability levels. One test method used for compaction control in earthwork, the modified Proctor test (ASTM D1557), tests a wide range of compaction characteristics and provides an indication of workability for a specific material. The modified Proctor test varies the moisture content of a mixture over a wide range, from extremely dry (Vebe less than 30 seconds) or drier (Vebe greater than 30 seconds). The modified Proctor test is used in earthwork projects to determine an optimum moisture and maximum dry density that is suitable for vibratory compaction, typically with 6 to 9 in. (150 to 230 mm) compacted lift thickness. Some RCC mixtures have contained such low paste volumes that workability could not be measured by the Vebe apparatus. This is particularly true of those mixtures proportioned with



Fig. 3.1—ASTM C1170 Vebe consistency test apparatus with 27.5 lb (12 kg) surcharge. (Photo courtesy of U.S. Department of Agriculture, National Resources Conservation Service, 2008.)

very low cementitious materials contents or designed more as cement stabilized fills. Workability of these types of mixtures needs to be judged by observations during placement and compaction, and by compacted density and moisture content measurements.

The water demand for a specific level of workability will be influenced by the size, shape, texture, and gradation of aggregates and the volume and nature of cementitious and fine materials. Depending on the paste volume, water demand can be established by Vebe time or by the moisture-density relationship, discussed in a following section.

**3.3.2 Strength**—RCC strength depends on the quality and grading of the aggregate, mixture proportions, and the degree of compaction. There are differing basic strength relationships for RCC, depending on whether the aggregate voids are completely filled with paste or not. The water-cement ratio ( $w/c$ ) law, as developed by Abrams (1918), is only valid for fully consolidated concrete mixtures. Therefore, the compressive strength of RCC is a function of the water-cementitious material ratio ( $w/cm$ ) only for fully compacted mixtures, with a measurable Vebe consistency usually in the 15- to 45-second range. Figure 3.2 shows this general relationship. For drier-consistency (all voids not filled with paste) mixtures, compressive strength is controlled by moisture-density relationships. With the same aggregate, the moisture content necessary to produce maximum dry density is less than the moisture required to produce an RCC mixture with a Vebe time in the range of 15 seconds. In general, the optimum moisture content does not vary significantly (on the order of 0.5 to 1%) for a wide range of cementitious contents.

Mixtures that contain less-than-optimum moisture are usually poorly compacted, with a resulting loss in density and strength. In this case, the addition of water to the mixture produces higher compressive strength by increasing the paste volume and filling voids. For fully consolidated mixtures exceeding optimum moisture, slight decreases in

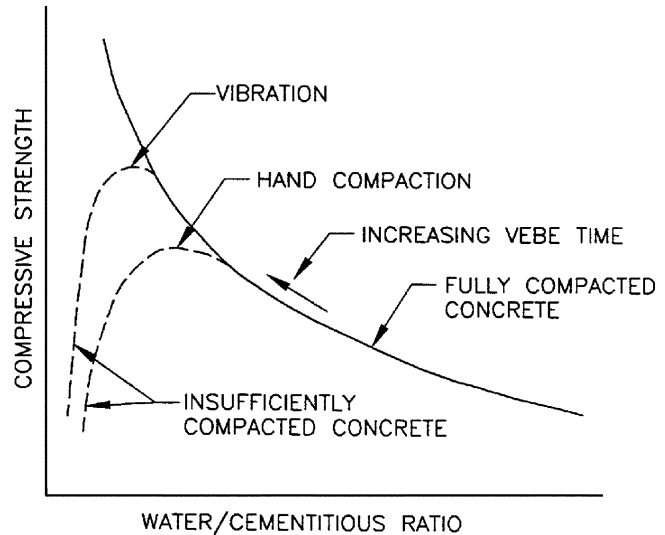

Fig. 3.2—General relationship between compressive strength and  $w/cm$ .

moisture content tend to produce a higher compressive strength. The design strength is usually not determined by the compressive stresses in the structure, but is more dependent on the required tensile strength, shear strength, and durability, particularly along lift surfaces. These are usually dictated by dynamic and static structural analyses, combined with an analysis of thermal stresses. Compressive strength is generally regarded as the most convenient indicator of the quality and uniformity of the concrete. Therefore, the design compressive strength is usually selected based on the level of strength necessary to satisfy compressive, tensile, and shear stresses plus durability under all loading conditions.

RCC mixtures should be proportioned to produce the design compressive strength plus an overdesign factor based on expected strength variation. Statistical concepts, as presented in ACI 214R, can be used for this purpose. For example, if the design strength is 2500 psi (17.2 MPa) at 1 year, and the expected standard deviation is 600 psi (4.1 MPa) with no more than two in 10 tests allowed below the design strength, the required average strength would be equal to the design strength plus 500 or 3000 psi (3.5 or 20.7 MPa). The RCC mixture should then be proportioned for a 3000 psi (20.7 MPa) strength at 1 year. Similar to conventional concrete, a lower standard deviation will permit a reduction in required average strength. The cost of controlling strength variation should be balanced against project needs and the savings that may be realized.

Compressive strength of RCC is usually determined on 6 x 12 in. (150 x 300 mm) cylindrical specimens. Specimens can be prepared using a vibrating table, as described in ASTM C1176/C1176M for more workable mixtures, or can be compacted by a tamping/vibrating hammer, as described in ASTM C1435/C1435M for a wide range of materials, workability, and paste volumes, including drier consistency mixtures. Cylinder molds should be steel or supported by a steel sleeve if plastic or sheet metal cylinder molds are used.



These methods use the fraction of the RCC mixture that passes the 2 in. (50 mm) sieve.

**3.3.3 Segregation**—A major goal in the proportioning of RCC mixtures is to produce a cohesive mixture while minimizing the tendency to segregate during transporting, placing, and spreading. Well-graded aggregates with a slightly higher fine aggregate content than conventional concrete are essential. If not proportioned properly, RCC mixtures tend to segregate more because of the low paste volume of the mixture. This is controlled by aggregate grading, moisture content, and adjustment of fine content in lower cementitious-content mixtures. Higher paste-content mixtures are usually more cohesive and less likely to segregate.

**3.3.4 Permeability**—Mixtures that have a paste plus fines volume of 18 to 22% by mass will provide a suitable level of impermeability that is similar to conventional mass concrete in the unjointed mass of the RCC. Most concerns regarding RCC permeability are directed at lift-joint seepage. Higher cementitious-content or high-workability mixtures that bond well to fresh lift joints will produce adequate watertightness. Lower-cementitious-content or low-workability mixtures are not likely to produce adequate watertightness without special treatment, such as use of bedding mortar between lifts. Where a seepage cutoff system is used on the upstream face, the permeability of the RCC may be of little significance except as it may relate to freezing-and-thawing resistance of exposed surfaces.

**3.3.5 Heat generation**—RCC mixture proportioning for massive structures should consider the heat generation of the cementitious materials. To minimize the heat of hydration, care should be taken in the selection and combination of cementing materials used. In cases where pozzolan is used, it is worthwhile to conduct heat-of-hydration testing on various percentages of cement and pozzolan to identify the combination that generates the minimum heat of hydration while providing satisfactory strength. The amount of cementitious material used in the mixture should be no more than is necessary to achieve the level of strength needed. Proportioning should incorporate those measures that normally minimize the required content of cementitious material, such as appropriate NMSA and well-graded aggregates. Further guidance in controlling heat generation can be found in ACI 207.1R, 207.2R, and 207.4R.

**3.3.6 Durability**—The RCC mixture should provide the required degree of durability based on materials used, exposure conditions, and expected level of performance. RCC should be free of damaging effects of alkali-aggregate reactivity by proper evaluation and selection of materials. Recent work indicates that some air-entrained RCC can be produced with adequate freezing-and-thawing resistance (McDonald 2002). If air entrainment cannot be achieved and the RCC is exposed, consideration should be given to increasing the strength for improved durability. RCC surfaces exposed to flowing water performed well where exposure has been of short duration and intermittent. Freezing-and-thawing resistance and erosion should not be a major concern during mixture proportioning if it will be protected with conventional concrete. The durability of RCC

can be significantly reduced if the mixture is not fully compacted. Though this is partially a construction control problem, a mixture proportioned with a paste volume sufficient for compaction can greatly improve its durability.

**3.3.7 Construction conditions**—Construction requirements and equipment should be considered during mixture proportioning. Some construction methods, placement schedules, and equipment selections are less damaging to compacted RCC than others. A higher workability mixture may result in a compacted RCC surface that tends to rut from hauling trucks and rollers. Wheeled traffic may produce severe rutting and should be restricted from operating on the compacted surface of the last lift of the day before it reaches final set. Rutting of the lift surface at Elk Creek Dam and Upper Stillwater Dam was observed to exceed 3 in. (75 mm). Severe rutting is generally not desirable because ruts inhibit joint cleanup and treatment. Timely finish rolling helps recompact the ruts after the end of the placement. Placing conditions with many obstacles that require smaller compaction equipment benefit from mixtures having a higher level of workability.

### 3.4—Mixture proportioning methods

**3.4.1 General**—A number of mixture proportioning methods have been successfully used for RCC structures throughout the world. These methods have differed significantly due to the location and design requirements of the structure, availability of materials, the mixing and placing equipment used, and time constraints. Most mixture-proportioning methods are variations of two general approaches: 1) a *w/cm* approach with the mixture proportions determined by solid volume; and 2) a cemented-aggregate or soils approach with mixture proportions determined by either solid volume or moisture-density relationship. Both approaches are intended to produce quality concrete suitable for roller compaction and mass concrete construction. The basic concepts behind these approaches are covered in ACI 211.3R, Appendix 3. Mixture proportions used for some RCC dams are shown in Table 3.1.

RCC mixture proportions can follow the convention used in traditional concrete practice where the mass of each ingredient contained in a compacted unit volume of the mixture is based on saturated surface-dry (SSD) aggregate condition. A practical reason for use of this standard convention is that concrete properties are the primary control parameters and, hence, conventional concrete practice should reduce the potential for miscommunication. For example, RCC mixing using conventional concrete plants require that mixture constituents be identified based on SSD aggregate conditions for input to the plant control system. This is not necessarily the case for continuous mixing plants, however. Mixture proportions may have to be converted to percent by dry weight of aggregate for RCC mixing in continuous mixing plants. Another reason supporting the concrete approach is that the RCC is typically placed and measured to specified lines, grades, and dimensions. The concrete proportioning method provides a means for establishing if the mixture is yielding properly (batched volume corresponds correctly to placed volume once compaction is factored); this is much

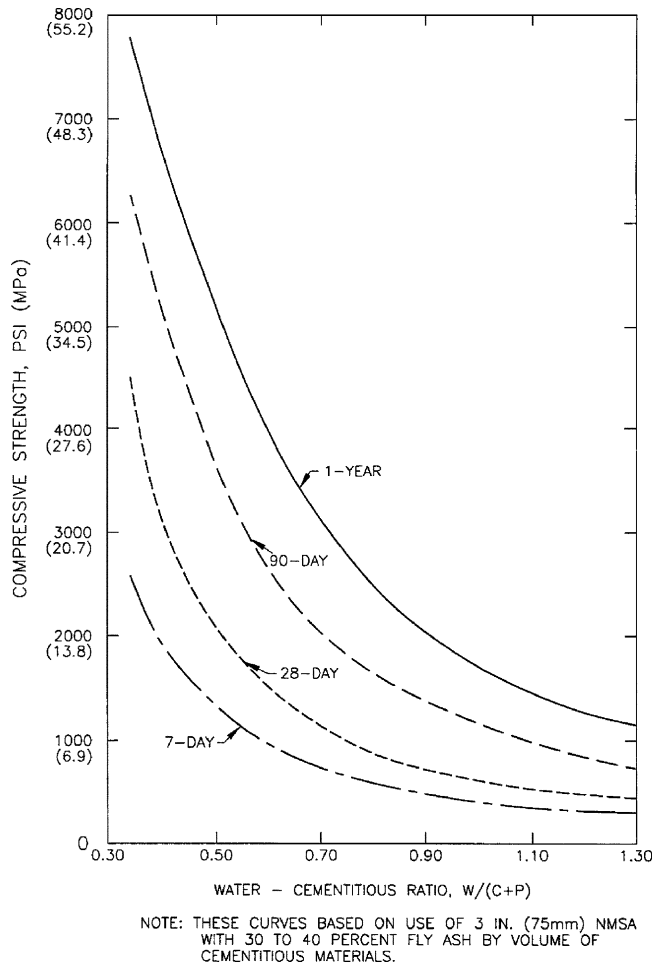

Fig. 3.3—Compressive strength versus  $w/cm$  (USACE 1992).

more difficult with a soils approach maximum density method discussed in Section 3.4.5.

**3.4.2 USACE method**—This proportioning method is based on  $w/cm$  and strength relationships and is very similar to proportioning conventional concrete mixtures (Tatro and Hinds 1992; USACE 2000). Appendix 3.6 of ACI 211.3R contains a similar method. Both methods calculate mixture quantities from solid volume determinations, as used in proportioning most conventional concrete. The  $w/cm$  and equivalent cement content are established from figures based on the strength criteria using Fig. 3.3 and 3.4. The complete step-by-step procedure for selecting mixture proportioning is presented in Chapter 3 of USACE EM 1110-2-2006 (USACE 2000). The approximate water demand is based on NMSA and desired modified Vebe consistency using a surcharge mass of 27.5 lb (12.5 kg). A recommended fine aggregate content as a percentage of the total aggregate volume is based on the nominal maximum size and nature of the coarse aggregate. Once the volume of each ingredient is calculated, a comparison of the mortar content to recommended values can be made to check the proportions. This method also provides several unique aspects, including ideal combined coarse aggregate grading and fine aggregate grading limits incorporating a higher percentage of fine sizes than permitted by ASTM C33/C33M. Because design

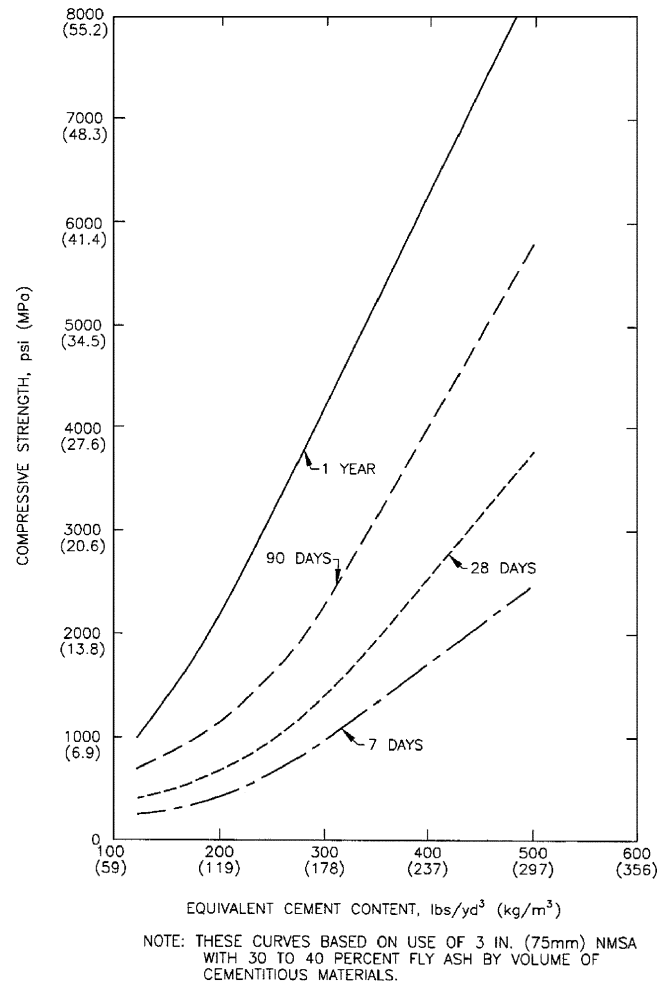

Fig. 3.4—Equivalent cement content versus compressive strength (USACE 1992).

strength for many RCC dams is based on 1 year, a target 90- or 180-day strength may be estimated using Fig. 3.3 and 3.4.

**3.4.3 U. S. Bureau of Reclamation high paste method**—This mixture proportioning method was developed by the U.S. Bureau of Reclamation for use during the design of Upper Stillwater Dam based on the original concepts of Dunstan (1985). The resulting mixtures from that testing program generally contained high proportions of cementitious materials, high pozzolan contents, clean and normally graded aggregates, and high workability. The purpose of the Upper Stillwater Dam mixtures was to provide excellent lift-joint bond strength and low joint permeability by providing sufficient cementitious paste in the mixture to enhance performance at the lift joints. Thus, the tensile and shear strength controlled the mixture proportions, and the ultimate compressive strength was higher than what was necessary for design purposes.

The proportioning method is summarized in Table 3.3 (U. S. Bureau of Reclamation 2005). The high paste method involves the same method of determining  $w/cm$  and fly ash-cement ratios, as described previously (USACE 2000) for the desired strength level and strength gain. The optimum water, fine aggregate, and coarse aggregate ratios are determined by trial batches, evaluating the Vebe consistency

**Table 3.3—Methodology for proportioning mass RCC mixtures using consistency tests**

Step 1: Determine design/construction criteria		Example
Design strength		3500 psi (24.1 MPa ) at 1 year (average of 4250 psi [29.3 MPa])
Consistency		15 to 20 seconds
W/(C+P) ratio (from strength curve)		0.57
Select NMSA (crushed coarse aggregate), percent sand		2 in. (50 mm), 35% (volume of total aggregate)
Entrained air? No (assume 1% air) or Yes (assume 4% air)		1% or 4% by volume
SSD water content		160 lb/yd <sup>3</sup> (95 kg/m <sup>3</sup> ) for no air, 150 lb/yd <sup>3</sup> (90 kg/m <sup>3</sup> ) for air-entrained admixtures, add 10 lb/yd <sup>3</sup> (5 kg/m <sup>3</sup> ) for crushed aggregate
Percent pozzolan (based on design strength age)		60% by mass of C+P
Cement plus pozzolan content (from W/(C+P) ratio)		300 (120 C + 180 P) (180[70 C + 110P])
Sand and coarse aggregate content		Calculate cement and pozzolan content, mortar volume, total aggregate content, sand and coarse aggregate content
Proportioning trials (as required)	Fresh properties evaluation criteria	Hardened properties evaluation criteria
<b>Step 2: Vebe consistency and density versus water content</b> (Vary SSD water content from 150 to 200 lb/yd <sup>3</sup> [90 to 120 kg/m <sup>3</sup> ] in 10 to 20 lb/yd <sup>3</sup> [6 to 12 kg/m <sup>3</sup> ] increments in 6 to 12 )	SSD water content versus change in consistency and density. Density as a percent of theoretical density. Consistency versus segregation. Note: maintain C+P content, sand-coarse aggregate ratio (adjust total aggregate volume to maintain yield)	W/(C+P) ratio versus compressive strength for constant C+P content. Compressive strength versus compaction. Compressive strength versus age.
<b>Step 3: Vebe consistency and density versus sand content</b> (Vary sand content from 30 to 45% in 3 to 5% increments) (if necessary, adjust water content for 15-second Vebe consistency)	Evaluate consistency and density, segregation. Determine optimum sand:aggregate ratio and if necessary, adjust water content for Vebe consistency of 15 seconds.	Compressive strength versus compaction. W/(C+P) ratio versus compressive strength.
<b>Step 4: Cement plus pozzolan content versus compressive strength</b> (Vary C+P content in 25 to 50 lb/yd <sup>3</sup> [15 to 30 kg/m <sup>3</sup> ] increments from about 200 to 350 lb/yd <sup>3</sup> [120 to 210 kg/m <sup>3</sup> ])	Optimum water and sand content selected for 15-second consistency. C+P (paste content) versus consistency. C+P (paste content) versus segregation.	W/(C+P) ratio versus compressive strength for constant water content. Compressive strength versus age. C+P content versus adiabatic temperature rise (optional).
<b>Step 5: Cement-pozzolan ratio versus rate of compressive strength development</b> (Vary C:P ratio for a fixed C+P content in 10 to 25% increments)	Cement : pozzolan ratio versus consistency. Cement : pozzolan ratio versus segregation.	Cement:pozzolan ratio versus compressive strength. Cement:pozzolan ratio versus rate of compressive strength development. Cement:pozzolan ratio versus adiabatic temperature rise (optional).
<b>Step 6: Select optimum mixture proportions and cast test specimens for the final mixture</b>		Strength and elastic properties. Thermal properties; adiabatic temperature rise. Bond strength properties (direct tensile strength, cohesion, friction properties). Durability.
<b>Step 7: Construct laboratory test scale section</b>	SSD water content versus change in consistency and density.	Compressive strength versus density/ compaction. Bond strength properties (direct tensile strength, cohesion, friction properties).

Note: Source: U.S. Bureau of Reclamation (2005).

for a range of 10 to 30 seconds. The required volumes and mass of aggregate, cement, pozzolan, water, and air are then calculated, maintaining the yield for each batch.

Laboratory trial mixtures are evaluated to verify acceptable workability, strength, and other required properties for the mixture. The number of mixtures is dependent on the scope of the job, ranging from trials to determine the optimum water content only to laboratory scale test sections for bond strength test specimens. Specific mixture variations may be performed to evaluate their effect on the fresh properties, such as consistency and hardened strength properties to optimize the mixture proportions. Strength specimens are fabricated with a vibrating table using ASTM C1176/C1176M or C1435/C1435M. Typical *w/cm* versus compressive strength relationships for different test ages are shown in Fig. 3.5.

**3.4.4 Roller-compacted dam method**—The roller-compacted dam (RCD) method was developed by Japanese engineers and is used primarily in Japan (Technical Center

for National Land Development 1981). The method is similar to proportioning conventional concrete in accordance with ACI 211.1 except that it incorporates the use of a consistency meter. The consistency meter is similar to the Vebe apparatus in that the RCC mixture is placed in a container and vibrated until mortar is observed on the surface. The device is sufficiently large to allow the full mixture, often 6 in. (150 mm) NMSA, to be evaluated rather than having to screen out the oversized particles.

The procedure consists of determining relationships between the consistency, called the VC value, and the water content, sand-aggregate ratio, unit weight of mortar, and compressive strength. The proper RCD mixture is the optimum combination of materials that meets the specific design criteria. Because of the consistency test equipment requirements and differences in the nature of RCD design and construction, this method is not widely used in proportioning RCC mixtures outside of Japan.

## Compressive Strength vs. W/(C+P) ratio

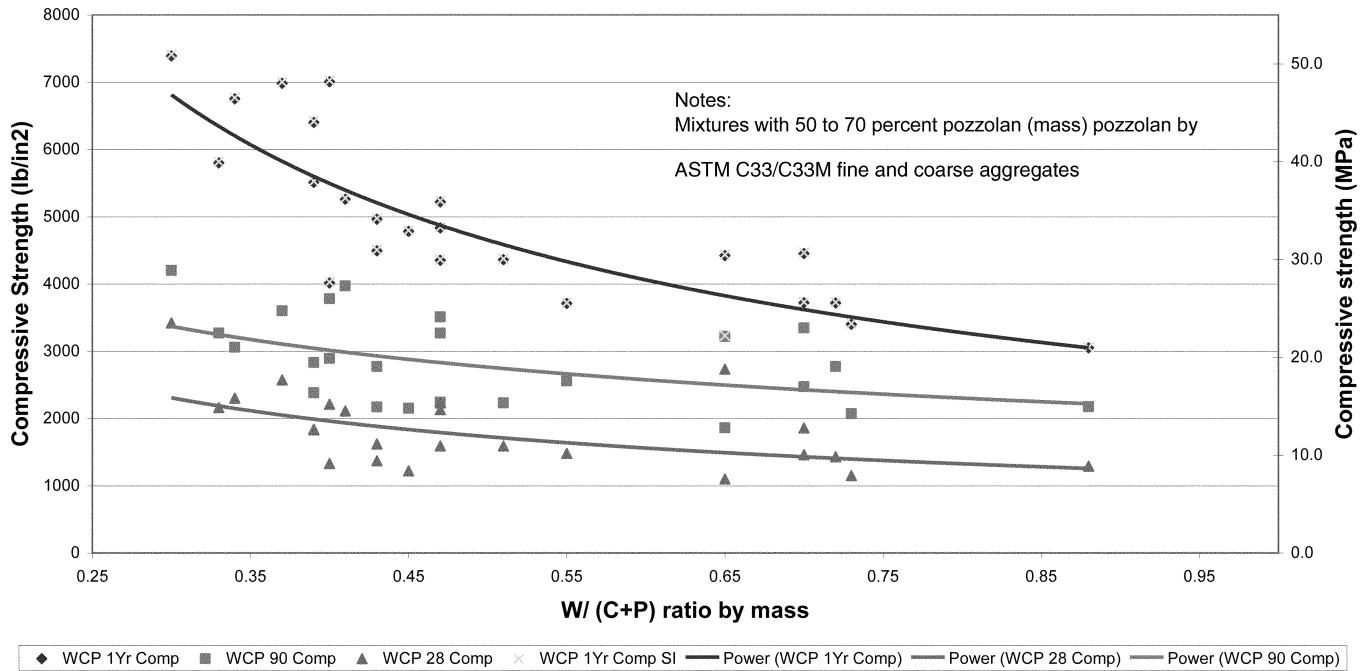

Fig. 3.5—Compressive strength versus w/cm for mixtures with clean graded aggregates.

**3.4.5 Maximum density method**—This method is a geotechnical engineering approach similar to that used for developing soil-cement- and cement-stabilized base mixtures (Reeves and Yates 1985). Instead of determining the water content by Vebe time or visual performance, the desired water content is determined by moisture-density relationship of compacted specimens using ASTM D1557. Various modifications to the ASTM standard have been found to be desirable because the ASTM D1557 method was not developed for material larger than 3/4 in. (19.0 mm) in diameter (Method D is not included in the current standard), and is not suitable at relatively high levels of workability (Arnold et al. 1992). Proportioning by this approach is also covered in Appendix 3.7 of ACI 211.3R.

### 3.5—Laboratory trial mixtures

**3.5.1 General**—It is recommended that a series of mixtures be proportioned and laboratory trial-mixed to encompass the potential range of performance requirements. This practice will allow later mixture modifications or adjustments without necessarily repeating the mixture evaluation process. Final adjustments should be made based on full-size field trial batches, preferably in a test strip or section where workability and compactibility can be observed.

**3.5.2 Visual examination of fresh concrete**—Several characteristics can be determined by visual examination of laboratory-prepared trial mixtures. Distribution of aggregate in the mixture, cohesiveness, and tendency for segregation are observable by handling the mixture on the lab floor with shovels. The texture of the mixture (harsh, unworkable, gritty, pasty, or smooth) can be seen and felt with the hand. These characteristics should be recorded for each mixture.

**3.5.3 Testing**—Laboratory tests, including temperature, consistency, unit weight, and air content, should be performed by ACI-certified technicians on the fresh RCC produced from each trial mixture. In addition, specimens should be prepared for compressive strength testing at various ages, usually 7, 28, 90, 180 days, and 1 year to indicate the strength gain characteristics of each mixture. These specimens can also be used for determination of static modulus of elasticity and Poisson's ratio at selected ages. Additional specimens should also be fabricated for splitting tensile strength (ASTM C496/C496M) or direct tensile strength at various ages to establish their relationship to compressive strength, and to provide parameters for use in structural analysis.

On major projects, specimens for thermal properties, including adiabatic temperature rise, coefficient of thermal expansion, specific heat, thermal conductivity, and diffusivity are usually cast from one or more selected RCC mixtures. Specimens for specialized tests such as creep, tensile strain capacity, and shear strength may also be cast from these mixtures. Many commercial laboratories are not equipped to conduct these tests, and special arrangements may be required with the U.S. Army Corps of Engineers, U.S. Bureau of Reclamation, or universities that have the equipment and facilities for this work. Commercial laboratories used should be accredited in accordance with ASTM C1077 and E329.

### 3.6—Field adjustments

The primary purpose of laboratory mixture proportioning is to provide proportions that when batched, mixed, and placed in the field, will perform as intended. Laboratory conditions, however, seldom perfectly duplicate field conditions due to ambient temperature and humidity,

batching accuracies, differences in mixer size and mixing action, changes in materials and material grading, compaction equipment, RCC curing, and time between adding water and compaction. In spite of these differences, laboratory mixture proportioning has proven to be an effective means to ensure RCC performance and to minimize field adjustments.

Field adjustments should include: 1) adjustment of aggregate percentages based on stockpile grading for each individual size range to produce the required combined grading; 2) correction of batch weights for aggregate moisture contents; and 3) adjustment of water content for the desired consistency or degree of workability based on consistency and workability of the mixture. Field adjustments should be done with caution to ensure the original mixture  $w/cm$  or other critical mixture requirements are not exceeded or misrepresented.

Before use in permanent work, it is recommended that the proposed RCC mixture be proportioned and mixed in full-size batches and placed, spread, and compacted in a test strip or section using the specified construction procedures. The test strip or section will provide valuable information on the need for minor mixture modifications, and can be used to determine the number of roller passes required for full compaction of the RCC mixture. A test strip or section can also be used to visually examine the condition of lift joints and potential for mixture segregation.

## CHAPTER 4—PROPERTIES OF HARDENED ROLLER-COMPACTED CONCRETE

### 4.1—General

The properties of hardened RCC are similar to those of mass concrete. Some differences between RCC and conventional mass concrete exist, however, primarily due to differences in required strength, paste volume, and voids content of the RCC mixtures. Most RCC mixtures are not air entrained and may also use aggregates that do not meet the quality or grading requirements of conventional mass concrete. RCC mixtures may also use a higher percentage of pozzolan, which affects the rate of strength gain, workability, and heat generation of the mixture. Because some RCC mixtures may use lower-quality aggregates and lower cementitious contents than conventional concretes, the range of hardened properties of RCC is greater than the range of properties of conventional concrete.

Designers should also be aware of the potential for increased variability of hardened RCC properties due to the potential for greater variations in materials and degree of compaction compared with conventional concrete. Lower-quality aggregates are those that may not meet the requirements for conventional concrete aggregates, either in durability or grading, or those that have been processed without washing. The use of these materials should be carefully considered by the designer and evaluated based on required performance. The rapid placing rates common in RCC construction can place construction loads on concrete before it reaches its initial set; therefore, early-age testing of performance may be needed for the design. The designer should be aware of the potential impact of low early-age strength on construction activities such as form support, vehicle access, and lift surface cleanup.

### 4.2—Strength

**4.2.1 Compressive strength**—Compressive strength tests are performed in accordance with ASTM C39/C39M during the design phase to determine mixture proportion requirements, and also to optimize combinations of cementitious materials and aggregates. Compressive strength is used to satisfy design loading requirements and also as an indicator of other strength properties or durability. Tests of cores from trial placement areas may be used to evaluate strength of RCC for design purposes, and also to evaluate the effects of compaction methods on these properties. During construction, compressive strength tests are used to confirm design properties, to evaluate mixture variability, and to provide data for future designs. Cores extracted in accordance with ASTM C42/C42M after construction is complete may be used to confirm design assumptions, construction practices, and may be used to further evaluate in-place properties of the structure. It is important to recognize that the compressive strength test results during construction will lag far behind production, and that maintaining quality can only be achieved as the RCC is mixed, placed, and compacted. Additionally, it is difficult to get reliable compressive strength results from low-strength cores taken too early following construction (though the cores can be used to evaluate compaction).

The compressive strength of RCC is influenced by water content, cementitious content, properties of the cementitious materials, aggregate grading, aggregate quality, and the degree of compaction. For fully-compacted RCC, the traditional influence of  $w/cm$  on compressive strength is valid. Replacement of cement in an RCC mixture with pozzolan typically delays the early strength development of RCC. Mixtures proportioned for later-age strengths, such as at 180 days or 1 year, often show no loss in strength, resulting in replacement of a significant portion of cement with pozzolan (Dolen 2003).

RCC mixtures with low cementitious contents or poorly-graded aggregates may not achieve anticipated strength levels if aggregate voids are not completely filled. For these mixtures, the addition of nonplastic fines or rock dust has been beneficial in filling voids, thus increasing the density and strength. The use of plastic (clay) fines in RCC mixtures adversely affects strength and workability and, therefore, is not recommended.

Significant differences in compaction have been observed to affect the strength of RCC in both the laboratory and in core samples extracted from in-place construction. For laboratory specimens, the energy imparted to the fresh mixture should be sufficient to achieve full compaction, or strength will not reach the required level due to increased voids. The compactive effort in the laboratory may be compared with cores extracted from a trial placement of simulated construction, provided that the test section has sufficient strength to be cored. The compressive strength of concrete will also decrease due to insufficient compaction that can occur near the bottom of the lift when RCC has poor workability. Not only does this affect compressive strength, but also density, bond strength, and permeability. Compressive strength might also decrease due to delays in completing compaction. Mixtures containing fly ash,

**Table 4.1—Compressive strength of some RCC dams: construction control cylinders**

Dam/project	Mixture type/ ID	Cement, lb/yd <sup>3</sup> (kg/m <sup>3</sup> )	Pozzolan, lb/yd <sup>3</sup> (kg/m <sup>3</sup> )	<i>w/cm</i>	NMSA, in. (mm)	Cylinder fabrication method	Compressive strength, psi (MPa), at test age				
							7 days	28 days	90 days	180 days	365 days
Al Wehdah	70C60F	118 (70)	101 (60)	0.96	2 (50)	VB	590 (4.1)	1130 (7.5)	2120 (14.6)	2510 (17.3)	3280 (22.6)
	60C70F	101 (60)	101 (60)	1.04	2 (50)	VB	440 (3.0)	800 (5.5)	1420 (9.8)	1750 (12.1)	2730 (18.8)
Camp Dyer	RCC1	139 (82)	137 (81)	0.55	1.5 (37.5)	VB	880 (6.1)	1470 (10.1)	—	—	3680 (25.4)
Concepcion	152C	152 (90)	0	1.03	3 (75)	PT	580 (4.0)	800 (5.5)	1100 (7.6)	1270 (8.8)	—
Galesville	RCC1	89 (53)	86 (51)	1.09	3 (75)	PT	300 (2.1)	580 (4.0)	1020 (7.0)	—	1620 (11.2)
	RCC2	110 (65)	115 (68)	0.84	3 (75)	PT	420 (2.9)	820 (5.7)	1370 (9.4)	—	—
Middle Fork	112C	112 (66)	0	1.43	3 (75)	PT	—	1270 (8.8)	1650 (11.4)	—	—
Olivenhain Trial Placement	100/100-180	100 (59)	100 (59)	0.90	2 (50)	HH	680 (4.7)	1010 (7.0)	1810 (12.5)	—	—
	100/100-195	100 (59)	100 (59)	0.98	2 (50)	HH	450 (3.1)	600 (4.1)	1410 (9.7)	—	—
Olivenhain	11B	127 (74)	204 (121)	0.63	2 (50)	HH	690 (4.8)	1070 (7.4)	1820 (12.6)	2990 (20.6)	—
Santa Cruz	RCCA EA	128 (76)	127 (75)	0.67	2 (50)	VB	1090 (7.5)	2730 (18.8)	3220 (22.2)	—	4420 (30.5)
Siegrist	100/70-162	100 (59)	70 (42)	0.95	1.5 (37.5)	PT	840 (5.8)	1360 (9.4)	2120 (14.6)	2630 (18.1)	2900 (20.0)
Stacey Spillway	210C105P	210 (125)	105 (62)	0.82	1.5 (37.5)	MP	—	2620 (18.1)	3100 (21.4)	—	—
Stagecoach	120C130P	120 (71)	130 (77)	0.93	2 (50)	PT	215 (1.5)	350 (2.4)	—	985 (6.8)	1250 (8.6)
Upper Stillwater	RCCA85	134 (79)	291 (173)	0.37	2 (50)	VB	1560 (10.8)	2570 (17.7)	3600 (24.8)	5590 (38.5)	6980 (48.1)
	RCCB85	159 (94)	349 (207)	0.30	2 (50)	VB	2040 (14.1)	3420 (23.6)	4200 (29.0)	5530 (38.1)	7390 (51.0)
	RCCA	134 (79)	292 (173)	0.39	2 (50)	VB	1080 (7.4)	1830 (12.6)	2600 (17.9)	—	6400 (44.1)
	RCCB	157 (93)	347 (206)	0.33	2 (50)	VB	1340 (9.2)	2230 (15.4)	3110 (21.4)	—	6750 (46.5)
Urugua-I	101C	101 (60)	0	1.67	3 (75)	PT	—	930 (6.4)	1170 (8.1)	—	1390 (9.6)
Willow Creek	175C	175 (104)	0	1.06	3 (75)	PT	1000 (6.9)	1850 (12.8)	2650 (18.3)	—	3780 (26.1)
	175C80P	175 (104)	80 (47)	0.73	3 (75)	PT	1150 (7.9)	2060 (14.2)	3960 (27.3)	—	4150 (28.6)
	80C32P	80 (47)	32 (19)	1.61	3 (75)	PT	580 (4.0)	1170 (8.1)	1730 (11.9)	—	2620 (18.1)
	315C135P	315 (187)	135 (80)	0.41	1.5 (37.5)	PT	2030 (14.0)	3410 (23.5)	4470 (30.8)	—	5790 (39.9)

Note: Cylinder fabrication method: VB = Vebe (ASTM C1176/C1176M); MP = modified proctor (ASTM D1557); PT = pneumatic tamper; and HH = Hilti Hammer.

**Table 4.2—Comparison of compressive strengths of RCC: construction control cylinders versus cores**

Dam/project	Mixture type/ID	Cement, lb/yd <sup>3</sup> (kg/m <sup>3</sup> )	Pozzolan, lb/yd <sup>3</sup> (kg/m <sup>3</sup> )	<i>w/cm</i>	NMSA, in. (mm)	Cylinder fabrication method	Cylinder strength, psi (MPa)			Core strength, psi (MPa)			
							28 day	90 day	365 day	Age, days	Strength	Age, days	Strength
Elk Creek	118C56P	118 (70)	56 (33)	1.00	3 (75)	VB	410 (3)	1370 (9)	2380 (16)	90	1340 (9)	730	2450 (17)
Galesville	RCC1	89 (53)	86 (51)	1.09	3 (75)	PT	580 (4)	1020 (7)	1620 (11)	425	2080 (14)	—	—
Middle Fork	112C	112 (66)	0	1.43	3 (75)	PT	1270 (9)	1650 (11)	—	42	2016 (14)	0	0
Olivenhain Trial Placement	100/100-180	100 (59)	100 (59)	0.90	2 (50)	HH	1010 (7)	1810 (12.5)	—	182	1700 (11.7)	—	—
	100/100-195	100 (59)	100 (59)	0.98	2 (50)	HH	600 (4.1)	1410 (9.7)	—	182	1620 (11.2)	—	—
Olivenhain	11B	125 (74)	204 (121)	0.63	2 (50)	HH	690 (4.8)	1820 (12.6)	—	91	2240 (15.4)	—	—
Penn Forest	90/71-155	90 (54)	71 (42)	0.96	1.5 (37.5)	HH	760 (5.2)	1490 (10.3)	2110 (14.6)	365	2015 (13.9)	—	—
Siegrist	100/70-162	100 (59)	70 (42)	0.95	1.5 (37.5)	PT	1360 (9.4)	2120 (14.6)	2900 (20)	335	3200 (22.1)	—	—
Stacey Spillway	210C105P	210 (125)	105 (62)	0.82	1.5 (37.5)	MP	2620 (18)	3100 (21)	—	28	2090 (14)	90	2580 (18)
Stagecoach	120C130P	120 (71)	130 (77)	0.93	2 (50)	PT	350 (2)	—	1250 (9)	180	1960 (14)	365	1920 (13)
Upper Stillwater	RCCA	134 (79)	292 (173)	0.39	2 (50)	VB	1830 (13)	2600 (18)	6400 (44)	180	4890 (34)	365	5220 (36)
Victoria	113C112P	113 (67)	112 (66)	0.80	2 (50)	—	—	—	—	365	2680 (18)	—	—
Willow Creek	175C	175 (104)	0	1.06	3 (75)	PT	1850 (13)	2650 (18)	3780 (26)	365	2120 (15)	—	—
	175C80P	175 (104)	80 (47)	0.73	3 (75)	PT	2060 (14)	3960 (27)	4150 (29)	365	2800 (19)	—	—
	80C32P	80 (47)	32 (19)	1.61	3 (75)	PT	1170 (8)	1730 (12)	2620 (18)	365	2250 (16)	—	—
	315C135P	315 (187)	135 (80)	0.41	1.5 (37.5)	PT	3410 (24)	4470 (31)	5790 (40)	365	3950 (27)	—	—
Zintel Canyon	125CNA	125 (74)	0	1.50	2.5 (63)	—	—	—	—	345	1510 (10)	—	—

Note: Cylinder fabrication method: VB = Vebe (ASTM C1176/C1176M); MP = modified proctor (ASTM D1557); PT = pneumatic tamper; and HH = Hilti Hammer.

retarding admixtures, or both, are less prone to strength loss resulting from delayed compaction. Placing in cool weather also extends the setting time and the subsequent compaction time.

Typical compressive strengths of RCC using field-fabricated cylinders are given in Table 4.1. Table 4.2 presents

a comparison of compressive strength of RCC cylinders versus cores. The design compressive strengths for these mixtures may vary from as low as 1000 psi (7 MPa) to as high as 4000 psi (28 MPa) at an age of 1 year. Strain and creep properties and corresponding compressive strength data from several RCC dam projects are listed in Table 4.3.

**Table 4.3—Strain and creep properties of some laboratory RCC mixtures**

Dam/project	Cement, lb/yd <sup>3</sup> (kg/m <sup>3</sup> )	Pozzolan, lb/yd <sup>3</sup> (kg/m <sup>3</sup> )	w/cm	Loading age, days	Creep coefficients		Compressive strength, psi (MPa)	Modulus of elasticity, 10 <sup>6</sup> psi (GPa)
					1/E, 10 <sup>-6</sup> /psi (10 <sup>-6</sup> /KPa)	f(K)		
Concepcion	152 (90)	0	1.20	7	1.4 (0.20)	0.12	640 (4)	—
	152 (90)	0	1.20	28	0.73 (0.11)	0.08	980 (7)	1.40 (10)
	152 (90)	0	1.20	90	0.47 (0.07)	0.03	1250 (9)	2.10 (14)
Upper Stillwater	182 (108)	210 (125)	0.47	28	1.05 (0.15)	0.11	2150 (15)	1.03 (7)
	129 (77)	286 (170)	0.43	28	0.66 (0.10)	0.04	2030 (14)	1.49 (10)
	129 (77)	286 (170)	0.43	180	0.57 (0.08)	0.01	4170 (29)	1.69 (12)
	121 (72)	269 (160)	0.45	180	0.62 (0.09)	0.02	3220 (22)	1.26 (9)
	182 (108)	210 (125)	0.47	365	0.57 (0.08)	0.02	4990 (34)	1.75 (12)
	121 (72)	269 (160)	0.45	365	0.57 (0.08)	0.01	4870 (34)	1.63 (11)
	182 (108)	210 (125)	0.47	90	0.84 (0.12)	0.06	3410 (24)	1.32 (9)
	129 (77)	286 (170)	0.43	365	0.53 (0.08)	0.02	5140 (35)	1.82 (13)
	182 (108)	210 (125)	0.47	180	0.67 (0.10)	0.03	4120 (28)	1.58 (11)
Willow Creek	80 (47)	32 (19)	1.61	7	1.97 (0.29)	0.20	580 (4)	1.20 (8)
	175 (104)	80 (47)	0.73	7	0.58 (0.08)	0.08	1150 (8)	2.40 (17)
	80 (47)	32 (19)	1.61	28	1.09 (0.16)	0.11	1170 (8)	1.59 (11)
	80 (47)	32 (19)	1.61	90	0.52 (0.08)	—	1730 (12)	1.91 (13)
	175 (104)	0	1.06	7	0.48 (0.07)	0.08	1000 (7)	2.20 (15)
	175 (104)	0	1.06	28	0.34 (0.05)	0.05	1850 (13)	2.67 (18)
Zintel Canyon	100 (59)	0	2.00	28	0.76 (0.11)	0.08	630 (4)	1.54 (11)
	100 (59)	0	2.00	90	0.47 (0.07)	—	1090 (8)	2.15 (15)
	100 (59)	0	2.00	365	0.39 (0.06)	—	1550 (11)	2.57 (18)
	200 (119)	0	1.00	7	0.76 (0.11)	0.05	990 (7)	1.54 (11)
	200 (119)	0	1.00	28	0.45 (0.07)	0.03	1620 (11)	2.39 (16)
	200 (119)	0	1.00	90	0.40 (0.06)	—	2130 (15)	2.47 (17)
	200 (119)	0	1.00	365	0.30 (0.04)	—	3100 (21)	3.28 (23)
	100 (59)	0	2.00	7	1.43 (0.21)	0.09	280 (2)	0.68 (5)

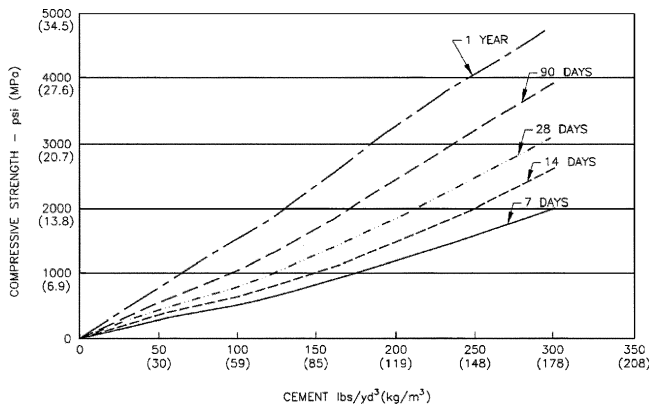

Fig. 4.1—RCC strength curves that can be developed from tests conducted on concretes with varying proportions of cement for high-quality aggregates.

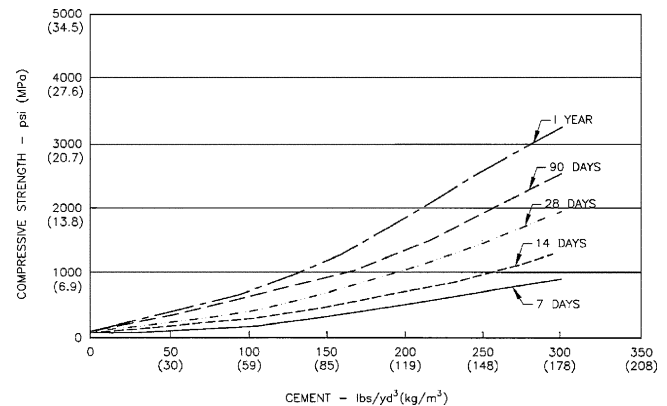

Fig. 4.2—RCC strength curves developed for lesser-quality aggregates.

Figures 4.1 and 4.2 show compressive strength curves developed for two different aggregates using a maximum density method for mixture proportioning.

**4.2.2 Tensile strength**—Tensile strength of RCC is required for design loadings, including dynamic loading and in the thermal analysis. Table 4.4 shows direct tensile strength values for core samples extracted from several projects. The ratios of direct tensile-to-compressive strength for parent (unjointed) RCC mixtures have typically averaged approximately 4 to 8%, depending on aggregate quality,

strength, age, and test method. Mixtures with low cementitious materials content, or those with lower-quality or coated aggregates, or both, will have corresponding lower direct tensile strengths. The ratio of direct tensile-to-compressive strength of both RCC and conventional mass concrete will usually decrease with increasing age and compressive strength (Schrader 1994). The direct tensile strength of concrete is less than the splitting (indirect) tensile strength of unjointed concrete. Splitting (indirect) tensile testing in accordance with

Table 4.4—Direct tensile strength of drilled cores of RCC dams

Dam/ project	Mixture type/ID	Cement, lb/yd <sup>3</sup> (kg/m <sup>3</sup> )	Pozzolan, lb/yd <sup>3</sup> (kg/ m <sup>3</sup> )	w/cm	NMSA, in. (mm)	Joint type	Age, days	Compressive strength, psi (MPa)	Tensile strength, psi (MPa)	Vebe time, s	Percent bonded joints	Joint maturity, °F-h	Test type	Comments
Mujib	143/0-6.0	143 (85)	0	—	2 (50)	P	365	1870 (12.9)	230 (1.6)	30 to 45	—	—	DT	
Olivenhain	11B	125 (74)	204 (121)	0.63	2 (50)	NB	90	2030 (14.0)	124 (0.9)	15	95	240	DT	
	11B	125 (74)	204 (121)	0.63	2 (50)	NB	90	2030 (14.0)	43 (0.3)	15	67	1700	DT	
	11B	125 (74)	204 (121)	0.63	2 (50)	B	90	2030 (14.0)	102 (0.7)	15	60	1740	DT	*
	11B	125 (74)	204 (121)	0.63	2 (50)	B	90	2030 (14.0)	169 (1.2)	15	75	7300	DT	†
	150/125-200	150 (89)	125 (74)	0.73	2 (50)	B	90	1200 (8.3)	105 (0.7)	15	70	320	DT	
	150/125-200	150 (89)	125 (74)	0.73	2 (50)	B	90	1200 (8.3)	123 (0.8)	15	90	1110	DT	
Olivenhain Design Trial Placement	100/100-195	100 (59)	100 (59)	0.98	2 (50)	B	200	1620 (11.2)	142 (1.0)	16	79	1170	DT	
	100/100-195	100 (59)	100 (59)	0.98	2 (50)	B	200	1620 (11.2)	144 (1.0)	16	97	170	DT	
	100/100-195	100 (59)	100 (59)	0.98	2 (50)	P	200	1620 (11.2)	151 (1.0)	16	—	—	DT	
Upper Stillwater	RCC B	150 (89)	328 (195)	0.35	2 (50)	NB	5000	4630 (31.9)	250 (1.7)	15	90	—	DT	
	RCC B	150 (89)	328 (195)	0.35	2 (50)	P	5000	4630 (31.9)	230 (1.6)	15	90	—	DT	
	RCC B	150 (89)	328 (195)	0.35	2 (50)	NB	365	5130 (35.4)	190 (1.3)	15	80	—	DT	
	RCC A	134 (80)	291 (173)	0.37	2 (50)	P	730	6500 (44.8)	280 (1.9)	30	60	—	DT	
	RCC A	134 (80)	291 (173)	0.37	2 (50)	NB	730	6500 (44.8)	230 (1.6)	30	60	—	DT	
	RCC A	134 (80)	292 (174)	0.39	2 (50)	NB	365	5220 (36.0)	200 (1.4)	15	80	—	DT	

\*Surface vacuumed before placing bedding mixture.

†Surface pressure washed and vacuumed before placing bedding mixture.

Notes: Joint type: B = bedding concrete or mortar; NB = no bedding; and P = parent concrete. Test type: DT = direct tensile; ST = splitting (indirect) tensile.

ASTM C496/C496M may be used, with appropriate data reduction, to determine parent tensile strength.

If the tensile strength of lift joints is needed, direct tensile strength testing is required. Designers should also consider anticipated construction and joint surface treatment methods in their design tensile strength assumptions. The direct tensile strength of RCC lift joints is not only dependent on the strength of the RCC mixture, but also on the maturity of the joint, the lift-joint surface preparation, degree of compaction and segregation at the lift interface, the maximum aggregate size, and the use and strength of a bonding mixture applied to the lift surface. Inadequate lift-surface cleanup, poor consolidation, or both, can drastically reduce the direct tensile strength of lift joints. Various surface preparation methods are discussed in Chapter 6. With adequate attention to lift surface preparation, the direct tensile strength of RCC lift joints averaged approximately 5% of the compressive strength. Testing of lift joints constructed using planned mixtures and placing procedures should be performed to confirm that required tensile strength can be achieved. The splitting tensile strength of the parent (unjoints) RCC has been assumed to be approximately 10% of the compressive strength.

**4.2.3 Shear strength**—Shear strength of lift joints is often a critical hardened property for RCC gravity dams. Total shear strength is the sum of cohesion plus internal friction for bonded, intact, lift joints. Shear resistance of unbonded lift joints includes apparent cohesion and sliding friction resistance between the lift surfaces. The minimum shear within the structure occurs at construction (lift) joints between lifts of RCC. Typical shear test values for parent RCC and bonded and unbonded joints are given in Table 4.5.

The designer should determine the required shear strength of lift joints, and also estimate a percentage of bonded lift joint that is likely to result from the planned construction methods. Past experience has shown that assuming 100% bonded lift joints is generally not valid. Decreased bond (cohesion) may result from insufficient paste volume in the RCC mixture, poor cleanup, excessive rain, excessive cure water, drying or freezing of the lift surface, and segregation or poor consolidation near the bottom of an RCC lift. The bond strength of RCC lift joints may be increased by using good construction joint surface treatment methods, increasing the strength or cementitious content of the mixture, placing RCC rapidly over a fresh joint surface, or application of a supplemental bonding mixture of bedding mortar or concrete between lifts. The cohesion of bonded lift joints in Table 4.5 averaged approximately 6 to 7.5% of the compressive strength for mixtures without and with a bonding mixture, respectively. Although difficult to quantify, the type of joint preparation, joint maturity, and moisture condition can significantly affect shear strength of bonded RCC lift joints. Thus, the shear properties can be significantly impacted by construction placing rates and ambient weather conditions that are not directly under the control of the designer.

The unconfined shear strength of unjointed (parent) RCC in Table 4.5 averaged approximately 13% of its compressive strength and ranged from approximately 8 to 21%. The unconfined shear strength of conventionally placed concrete, as determined by direct shear tests, generally ranges from approximately 20 to 25% of its compressive strength, but a conservative value of approximately 10% is often used in design. The coefficient of friction within the mass has been usually taken to be 1.0 ( $\phi = 45$  degrees) for RCC if no project-specific tests have been conducted.



**Table 4.5—Shear performance of drilled cores in RCC dams**

Dam/ project	Mixture type/ID	Cement, lb/yd <sup>3</sup> (kg/m <sup>3</sup> )	Pozzolan, lb/yd <sup>3</sup> (kg/m <sup>3</sup> )	w/cm	NMSA, in. (mm)	Joint type	Age, days	Core compressive strength, psi (MPa)	Peak cohesion, psi (kPa)	Shear φ, deg	Residual shear cohesion, psi (kPa)	Residual shear φ, deg	Vebe consis- tency, s	Bonded joints, %	Joint maturity, °F-h*	Comments
Cuchillo Negro	130C100P	130 (77)	100 (59)	0.99	3 (75)	B	750	2530 (17)	225 (1551)	58	—	—	—	—	—	
	130C100P	130 (77)	100 (59)	0.99	3 (75)	P	750	2530 (17)	360 (2482)	52	—	—	—	—	—	
	130C100P	130 (77)	100 (59)	0.99	3 (75)	NB	750	2530 (17)	100 (689)	62	—	—	—	—	—	
Elk Creek	118C56P	118 (70)	56 (33)	1.00	3 (75)	P	90	1340 (9)	225 (1551)	46	—	—	21	—	—	
	118C56P	118 (70)	56 (33)	1.00	3 (75)	B	90	1340 (9)	125 (862)	49	—	49	—	58	—	
Galesville	RCC1	89 (51)	86 (51)	1.09	3 (75)	NB	415	2080 (14)	110 (758)	67	80 (552)	40	—	24	500	
	RCC1	89 (51)	86 (51)	1.09	3 (75)	B	415	2080 (14)	330 (2275)	52	70 (483)	43	—	76	—	
	RCC1	89 (51)	86 (51)	1.09	3 (75)	P	415	2080 (14)	380 (2620)	33	95 (655)	45	—	—	—	
Mujib	143/0-6.0	143 (85)	0 (0)	—	2 (50)	P	365	1870 (12.9)	250 (1700)	—	—	—	30 to 45	—	—	Conveyor delivery
	143/0-6.0	143 (85)	0 (0)	—	2 (50)	P	365	1870 (12.9)	220 (1500)	—	—	—	30 to 45	—	—	Truck delivery
	143/0-6.0	143 (85)	0 (0)	—	2 (50)	B	365	1870 (12.9)	170 (1200)	—	—	—	30 to 45	—	—	Conveyor delivery
	143/0-6.0	143 (85)	0 (0)	—	2 (50)	B	365	1870 (12.9)	160 (1100)	—	—	—	30 to 45	—	—	Truck delivery
Olivenhain Trial Placement	100/100-195	100 (59)	100 (59)	0.98	2 (50)	B	205	1620 (11.2)	350 (2410)	63	109 (751)	39	16	79	1130	
	100/100-195	100 (59)	100 (59)	0.98	2 (50)	B	207	1620 (11.2)	305 (2100)	62	79 (540)	50	16	97	170	
	100/100-195	100 (59)	100 (59)	0.98	2 (50)	P	206	1620 (11.2)	337 (2320)	62	78 (540)	50	16	—	—	
Saluda Trial Placement	104/89-6.0	175 (104)	150 (89)	0.89	1.5 (37.5)	NB	365	2760 (19.0)	82 (570)	56	0	47	15 to 20	†	375	Lightly washed
	104/89-6.0	175 (104)	150 (89)	0.89	1.5 (37.5)	B	365	2760 (19.0)	210 (1480)	67	0	49	15 to 20	†	375	Lightly washed
	104/89-6.0	175 (104)	150 (89)	0.89	1.5 (37.5)	B	365	2760 (19.0)	10 (70)	66	0	45	15 to 20	†	750	Lightly washed
	74/89-6.3	125 (74)	150 (89)	0.91	1.5 (37.5)	NB	365	2610 (18.0)	12 (80)	49	0	42	38	†	375	Lightly washed
	89/89-6.8	150 (89)	150 (89)	0.86	1.5 (37.5)	NB	365	3190 (22.0)	46 (320)	45	0	43	25 to 35	†	750	Air blown
	89/89-6.8	150 (89)	150 (89)	0.86	1.5 (37.5)	B	365	3190 (22.0)	65 (450)	61	0	52	25 to 35	†	750	Air blown
	89/89-6.8	150 (89)	150 (89)	0.86	1.5 (37.5)	NB	365	3190 (22.0)	65 (450)	47	0	43	25 to 35	†	375	Air blown
	89/89-6.8	150 (89)	150 (89)	0.86	1.5 (37.5)	NB	365	3190 (22.0)	81 (560)	49	0	43	25 to 35	†	125	Air blown
	89/89-6.8	150 (89)	150 (89)	0.86	1.5 (37.5)	B	365	3190 (22.0)	38 (260)	67	0	42	25 to 35	†	125	Air blown
	104/89- 175 (104)	150 (89)	—	1.5 (37.5)	B	365	2760 (19.0)	0 (0)	64	0	45	35	†	375	Air blown	
104/89- 175 (104)	150 (89)	—	1.5 (37.5)	NB	365	2760 (19.0)	8 (55)	36	0	44	35	†	375	Air blown		
Upper Stillwater	RCCA	134 (79)	292 (173)	0.39	2 (50)	NB	365	5220 (36)	450 (3103)	53	30 (207)	49	17	80	—	
	RCCA	134 (79)	292 (173)	0.39	2 (50)	NB	545	5590 (39)	560 (3821)	76	20 (138)	53	17	—	—	
	RCCA85	134 (79)	291 (173)	0.37	2 (50)	P	120	3870 (27)	300 (2068)	55	30 (207)	42	29	60	—	
	RCCA85	134 (79)	291 (173)	0.37	2 (50)	NB	730	6510 (45)	440 (3034)	48	20 (138)	46	29	60	—	
	RCCB	150 (89)	328 (195)	0.35	2 (50)	P	5000	4630 (31.9)	570 (3900)	49	—	—	15	—	—	
	RCCB	150 (89)	328 (195)	0.35	2 (50)	NB	5000	4630 (31.9)	380 (2600)	52	—	—	15	90	24-h	
	RCCB	150 (89)	328 (195)	0.35	2 (50)	NB	5000	4630 (31.9)	650 (4500)	34	—	—	15	90	12-h	
Victoria	113C112P	113 (67)	112 (66)	0.80	2 (50)	P	365	2680 (18)	280 (1931)	64	40 (276)	47	730	—	—	
	113C112P	113 (67)	112 (66)	0.80	2 (50)	B	365	2680 (18)	230 (1586)	69	10 (69)	44	—	—	—	
	113C112P	113 (67)	112 (66)	0.80	2 (50)	NB	365	2680 (18)	170 (1172)	62	200 (1379)	48	—	—	—	
Willow Creek	175C	175 (104)	0	1.06	3 (75)	NB	200	—	185 (1278)	65	—	—	—	57	500	
	175C80P	175 (104)	80 (47)	0.73	3 (75)	NB	200	—	186 (1279)	63	—	—	—	54	500	
	80C32P	80 (47)	32 (19)	1.61	3 (75)	NB	200	—	115 (793)	62	—	—	—	58	500	
Zintel Canyon	125CNA	125 (74)	0	1.50	2.5 (63)	NB	345	1510 (10)	85 (586)	56	10 (69)	40	14	—	—	
	125CNA	125 (74)	0	1.50	2.5 (63)	B	345	1510 (10)	200 (1379)	54	10 (69)	40	14	65	—	
	125CNA	125 (74)	0	1.50	2.5 (63)	P	345	1510 (10)	290 (1999)	56	0	55	14	—	—	

\*Majority of Saluda test samples were purposely precracked at lift joint before testing.

†Except as noted.

Note: Joint type: B = bedding concrete or mortar; NB = no bedding; and P = parent concrete.

### 4.3—Elastic properties

**4.3.1 Modulus of elasticity**—Modulus of elasticity is typically a required input parameter for most stress analysis programs. In linear-elastic numerical analysis, a low modulus of elasticity may be desirable because it may predict lower stresses from an assumed linear stress-strain relationship versus a high-modulus material. In brittle

materials (and not modeled in linear elastic theory), however, ultimate failure strains used to predict stress may already be in the cracking (nonlinear) range for a low-modulus material, thus not correctly predicting stress by linear-elastic behavior. Principal factors affecting the elastic properties of RCC are age, strength, paste volume, and aggregate type. Generally, for a given aggregate type, the modulus of elasticity

Table 4.6—Compressive strength and elastic properties of some laboratory RCC mixtures

Dam/ project	Mixture type/ ID	Cylinder fabrication method	NMSA, in. (mm)	w/cm	Compressive strength, psi (MPa)				Modulus of elasticity, million psi (GPa)				Poisson's ratio			
					7 day	28 day	90 day	365 day	7 day	28 day	90 day	365 day	7 day	28 day	90 day	365 day
Concepcion	152C	PT	3 (75)	1.03	640 (4.4)	980 (6.8)	1250 (8.6)	1690 (11.7)	—	1.10 (7.58)	1.91 (13.17)	3.31 (22.82)	—	0.17	—	—
Mujib	143/0-6.0	PT	2 (50)		690 (4.8)	1020 (7.0)	1230 (8.5)	1870 (12.9)	0.9 (6.2)	1.62 (11.2)	2.77 (19.1)	3.39 (23.4)	—	—	—	—
Olivenhain	100/100-180	H	2 (50)	0.90	600 (4.1)	910 (6.3)	1440 (9.9)	2340 (16.1)	1.04 (7.17)	1.30 (8.97)	1.15 (7.93)	1.75 (12.07)	—	—	—	—
	125/125-180	H	2 (50)	0.72	640 (4.4)	1110 (7.7)	1720 (11.9)	3050 (21.0)	—	2.19 (15.10)	2.90 (20.00)	4.17 (28.76)	—	—	—	—
	225/0-180	H	2 (50)	0.80	1850 (12.8)	2600 (17.9)	2820 (19.4)	3000 (20.7)	2.10 (14.48)	2.43 (16.75)	2.45 (16.90)	3.53 (24.34)	—	—	—	—
Santa Cruz	1e	VB	2 (50)	0.88	640 (4.4)	1290 (8.9)	2180 (15.0)	3050 (21.0)	1.36 (9.38)	1.80 (12.41)	2.26 (15.58)	3.24 (22.34)	0.13	0.14	0.19	0.21
Siegrist	100/70	PT	1.5 (37.5)	0.95	630 (4.3)	890 (6.1)	1320 (9.1)	2030 (14.0)	0.58 (4.00)	0.92 (6.34)	1.58 (10.89)	3.00 (20.68)	—	—	—	—
Upper Stillwater	L1	VB	2 (50)	0.47	1360 (9.4)	2130 (14.7)	3510 (24.2)	5220 (36.0)	—	1.03 (7.10)	1.32 (9.10)	1.71 (11.79)	—	0.13	0.14	0.14
	L2	VB	2 (50)	0.45	770 (5.3)	1220 (8.4)	2150 (14.8)	4780 (33.0)	—	0.82 (5.65)	—	1.59 (10.96)	—	0.13	—	0.20
	L3	VB	2 (50)	0.43	1110 (7.7)	1620 (11.2)	2770 (19.1)	4960 (34.2)	—	0.92 (6.34)	—	1.76 (12.14)	—	0.13	—	0.18
Urugua-I	101C	PT	3 (75)	1.67	—	930 (6.4)	1170 (8.1)	1390 (9.6)	—	2.25 (15.51)	3.12 (21.51)	3.60 (24.82)	—	—	—	—
Willow Creek	175C	PT	3 (75)	1.06	1000 (6.9)	1845 (12.7)	2650 (18.3)	3780 (26.1)	2.20 (15.17)	2.67 (18.41)	2.78 (19.17)	—	—	0.19	0.18	—
	175C80P	PT	3 (75)	0.73	1150 (7.9)	2060 (14.2)	3960 (27.3)	4150 (28.6)	2.40 (16.55)	2.91 (20.06)	3.25 (22.41)	—	—	0.21	0.21	—
	80C23P	PT	3 (75)	1.61	580 (4.0)	1170 (8.1)	1730 (11.9)	2620 (18.1)	1.20 (8.27)	1.59 (10.96)	1.91 (13.17)	—	—	0.14	0.17	—
Zintel Canyon	100C1975	PT	3 (75)	2.00	280 (1.9)	630 (4.3)	1090 (7.5)	1550 (10.7)	0.68 (4.69)	1.54 (10.62)	2.15 (14.82)	2.57 (17.72)	—	—	0.21	—
	200C1975	PT	3 (75)	1.00	990 (6.8)	1620 (11.2)	2130 (14.7)	310 (21.4)	1.54 (10.62)	2.39 (16.48)	2.47 (17.03)	3.28 (22.62)	—	—	0.20	—

Note: Cylinder fabrication method: VB = Vebe (ASTM C1176/C1176M); PT = pneumatic tamper; HH = Hilti Hammer.

is a function of strength. Typical modulus of elasticity values for a variety of RCC mixtures are shown in Tables 4.3 and 4.6. The modulus of elasticity in tension is typically assumed to be the same as in compression.

**4.3.2 Poisson's ratio**—Values of Poisson's ratio for RCC, as indicated in Table 4.6, have ranged from approximately 0.17 to 0.22, with lower values occurring at earlier ages and with lower compressive strength mixtures. In general, Poisson's ratio values for RCC are similar to values reported for conventional concrete mixtures.

#### 4.4—Dynamic properties

The strength and material properties of conventional concrete have been measured for cyclic loadings and rapid strain rates to simulate dynamic loading conditions on dams during earthquakes. The ultimate compressive and tensile strength and elastic modulus generally increase under rapid dynamic loading conditions. To date, there are no known comparable test results for shear strength under similar dynamic loading conditions.

The usual increase in concrete modulus during dynamic loading is well documented by laboratory tests and the use of dynamic or rapid load concrete modulus for dynamic analysis is accepted practice (U. S. Bureau of Reclamation 1978; Clough and Zienkiewicz 1975; Lindvall, Richter, and

Associates 1975). A value of instantaneous dynamic concrete modulus is approximately 25% greater than the static modulus of elasticity, and can be used for preliminary studies in the absence of actual laboratory test data.

Dynamic strength values are dependent on the rate of loading. The results from historical laboratory tests on conventional concrete indicate an approximate 30% increase for compressive strength, and increases of slightly greater than 50% for tensile strength, based on splitting tensile or modulus of rupture tests of cast specimens under rapid dynamic loading conditions (U.S. Bureau of Reclamation 1977b; Raphael 1984; Soroushian et al. 1986). Recent tests of conventional mass concrete cores show the dynamic compressive strength ranges from 75 to 145% of the static strength, the dynamic modulus of elasticity in compression ranges from 70 to 110% of the static value, and the dynamic splitting tensile strength ranges from 80 to 130% of the static splitting tensile strength (Harris et al. 2000).

Laboratory testing should be performed to confirm the dynamic properties of RCC compared with static values. Currently, there are no published results of dynamic material properties tests for RCC. Field testing of existing RCC (based on both cast and cored specimens) shows that conventional concrete exhibits similar material properties.

Thus, it is generally considered acceptable practice to assume comparable increases for compressive and tensile strength and elastic modulus for RCC mixtures under dynamic loading conditions. In the absence of definitive test data for dynamic shear strength of conventional concrete or RCC, designers should choose reasonable values for evaluating designs for earthquake loads. The choice ranges from values of static shear strength to values based on the proportional relationship between ultimate compressive strength and shear strength. Until comparable testing of RCC specimens under dynamic loading conditions has been accomplished to confirm the validity of these relationships, a cautious implementation of this approach is suggested.

#### 4.5—Creep

Creep is a function of the material properties and proportions of components in the RCC mixture, modulus of elasticity, and compressive strength. Generally, high-strength mixtures have a more rigid cementing matrix and lower creep, whereas low-strength mixtures or those using aggregates with low modulus of elasticity will produce concretes with higher creep. Typical creep values for a variety of RCC mixtures are shown in Table 4.3. Higher creep properties are generally desirable to relieve stress and strain buildup resulting from foundation restraint, thermal conditions, and exterior loadings.

#### 4.6—Volume change

**4.6.1 Drying shrinkage**—Drying shrinkage is primarily governed by the water content of the mixture and, to a lesser extent, by the degree of aggregate restraint. Compared with conventional mass concrete, the volume change from drying shrinkage in RCC is similar or lower because of the reduced water content.

**4.6.2 Autogenous volume change**—Autogenous volume change is primarily a function of the material properties and proportions in the mixture. Similar to conventional concrete, autogenous volume change cannot be reliably predicted without laboratory testing. This is especially true for mixtures made with an unusual cement, pozzolan, or aggregate.

#### 4.7—Thermal properties

Thermal properties, including specific heat, conductivity, diffusivity, coefficient of thermal expansion, and adiabatic temperature rise, are of primary concern for both conventional and roller-compacted mass concrete. Thermal properties are governed by the thermal properties of the mixture constituents. Although values for conventional concrete and RCC are similar, the actual measured values can vary significantly depending on aggregate type, cement, pozzolan chemistry, and cementitious content. For this reason, testing using the full RCC mixture is recommended. Traditional test procedures for hardened concrete may not always be applicable to some RCC mixtures, particularly those with either low strength or high pozzolan contents. For example, the adiabatic temperature rise of mass concrete is normally tested for approximately 28 days, with most mixtures producing little temperature rise beyond that time. A high-pozzolan RCC mixture may have

significant delay in early-age temperature rise and increased temperature rise beyond 28 days. RCC mixtures with more than approximately 30% pozzolan should be tested for adiabatic temperature rise and other properties to an age of at least 56 days.

The adiabatic temperature rise is affected by the total cementitious materials content and percentage of pozzolan in the mixture. RCC mixtures with low cementitious materials content will have lower temperature rise than conventional mass concrete mixtures. Typically, pozzolans, such as Class F pozzolan, will produce an adiabatic temperature rise at 28 days of approximately one-half that of an equivalent weight of cement. Pozzolans may also reduce the rate of temperature rise at early ages. Table 4.7 shows typical adiabatic temperature rise and other thermal properties of some RCC mixtures.

#### 4.8—Tensile strain capacity

Strain is induced in concrete when a restrained volume change occurs. When the volume change results in strain that exceeds the tensile strain capacity of the material, a crack occurs. The threshold strain value just before cracking is the tensile strain capacity of the material. Tensile strains in concrete can be developed by external loads applied to the structure as well as by volume changes induced through drying, reduction in temperature, and autogenous shrinkage.

The major factors affecting tensile strain capacity are the strength and age of the concrete, rate of loading, type of aggregate, aggregate shape (angular, as produced by crushing, versus natural round), and cementitious content.

As with other material properties, tensile strain capacity can vary considerably because of the wide range of mixture proportions and variety of aggregates used to produce RCC. Each mixture should be evaluated if tensile strain capacity is used for crack analysis. USACE (2000) recommends determining the tensile strain capacity according to CRD-C 71.

#### 4.9—Permeability

The permeability of RCC is largely dependent on voids in the compacted mass together with porosity of the mortar matrix, and is therefore almost totally controlled by mixture proportioning, placement method, and degree of compaction. RCC will be relatively impervious when the mixture contains sufficient paste and mortar, an adequate fine particle distribution that minimizes the air void system, limited segregation of coarse aggregate, and full compaction. In general, an unjointed mass of RCC proportioned with sufficient paste will have permeability values similar to conventional mass concrete. Test values typically range from 0.3 to  $30 \times 10^{-9}$  ft/min. ( $0.15$  to  $15 \times 10^{-9}$  cm/s). High cementitious mixtures tend to have lower permeability than low cementitious mixtures.

If seepage occurs in RCC dams, it usually occurs along lift joints or through contraction joints or cracks rather than through the unjointed mass. If seepage occurs along lift joints, it also indicates a reduction in shear and tensile strength at this location.

Leakage can also be expected through cracks and monolith joints, regardless of the permeability of the RCC. Although

Table 4.7—Thermal properties of some laboratory RCC mixtures

Dam/ project	Mixture type/ID	Cement, lb/yd <sup>3</sup> (kg/ m <sup>3</sup> )	Pozzolan, lb/yd <sup>3</sup> (kg/m <sup>3</sup> )	Aggregate type	Specific heat, Btu °F (J/kg °C)	Diffusivity, ft <sup>2</sup> /h (m <sup>2</sup> /h)	Conductivity, Btu/ft-h °F (W/m °K)	Coefficient of expansion millionths/°F (millionths/°C)	Initial, °F (°C)	Adiabatic temperature rise			Comment
										Change in °F (°C)			
										3 day	7 day	28 day	
Concepcion	152CL	152 (90)	0 (0)	Ignimbrite	0.25 (1047)	0.03 (0.003)	1.1 (1.9)	6.2 (11)	67 (19.4)	21 (11.7)	24 (13.3)	25 (13.9)	—
Coolidge	124C124	124 (74)	124 (74)	Volcanics/ alluvial	—	—	—	—	63 (17.2)	23 (12.8)	28 (15.6)	35 (19.4)	—
Elk Creek	113C28P	113 (67)	28 (17)	Basalt/ sandstone	—	—	—	—	41 (5.0)	11 (6.1)	14 (7.8)	20 (11.1)	IP cement
	118C56P	118 (70)	56 (33)	Basalt/ sandstone	0.18 (754)	—	—	—	43 (6.2)	17 (9.4)	21 (11.7)	24 (13.3)	—
	94C38P	94 (56)	38 (23)	Basalt/ sandstone	0.18 (754)	0.03 (0.003)	1 (1.7)	3.9 (7.0)	44 (6.7)	13 (7.2)	16 (8.9)	20 (11.1)	—
Middle Fork	120C	120 (71)	—	Marlstone	—	—	—	—	60 (15.6)	17 (9.4)	22 (12.2)	27 (15.0)	—
Milltown Hill	111C112	111 (66)	112 (66)	Andesite/ basalt	0.25 (1047)	0.05 (0.005)	1.92 (3.3)	3.3 (5.9)	62 (16.7)	17 (9.4)	22 (12.2)	30 (16.7)	Maximum 32°F (18°C) at 54 days
Olivenhain	225/ 0-180	225 (134)	0 (0)	Granodiorite	—	—	—	5.4 (9.7)	—	—	—	—	—
	200/ 0-180	200 (119)	0 (0)	Granodiorite	—	—	—	—	69 (38)	28 (16)	33 (18)	35 (19)	—
	100/ 100-180	100 (59)	100 (59)	Granodiorite	0.21 (880)	0.03 (0.003)	0.94 (1.6)	—	58 (32)	17 (9.4)	21 (12)	24 (13)	—
Santa Cruz	1e	112 (66)	112 (66)	Alluvial granite	0.26 (1089)	0.04 (0.004)	1.67 (2.9)	3.0 (5.4)	61 (16.1)	25 (13.9)	29 (16.1)	33 (18.3)	AEA Type A WRA
Upper Stillwater	L1	182 (108)	210 (125)	Quartzite/ sandstone	—	0.06 (0.006)	—	4.9 (8.8)	60 (15.6)	25 (13.9)	34 (18.9)	45 (25.6)	Type D WRA
	L2	121 (72)	269 (160)	Quartzite/ sandstone	—	0.06 (0.006)	—	4.0 (7.2)	47 (8.3)	15 (8.3)	26 (14.4)	33 (18.3)	Type D WRA
	L3	129 (77)	286 (170)	Quartzite/ sandstone	—	—	—	—	45 (7.2)	4 (2.2)	20 (11.1)	34 (18.9)	Type D WRA
	L3A	127 (77)	286 (170)	Quartzite/ sandstone	—	0.06 (0.006)	—	4.9 (8.8)	49 (9.4)	16 (8.9)	28 (15.6)	37 (20.6)	Type A WRA
	L5	156 (93)	344 (204)	Quartzite/ sandstone	—	—	—	—	54 (12.2)	24 (13.3)	36 (20.0)	48 (26.7)	Type A WRA
Willow Creek	175C	175 (104)	0	Basalt	0.22 (921)	0.03 (0.003)	1.05 (1.8)	4.0 (7.2)	55 (12.7)	23 (12.8)	29 (16.1)	36 (20.0)	—
	175C80P	175 (104)	80 (47)	Basalt	0.22 (921)	0.03 (0.003)	1.05 (1.8)	4.0 (7.2)	52 (11.1)	23 (12.8)	29 (16.1)	36 (20.0)	—
	80C32P	80 (47)	32 (19)	Basalt	0.22 (921)	0.03 (0.003)	1.05 (1.8)	3.9 (7.0)	53 (11.7)	13 (7.2)	—	22 (12.2)	—
	315C135	315 (187)	135 (80)	Basalt	0.22 (921)	0.03 (0.003)	1.05 (1.8)	4.0 (7.2)	53 (11.7)	31 (17.2)	36 (20)	53 (29.4)	—
Zintel Canyon	100C197	100 (59)	0 (0)	Basalt/ gravel	0.23 (963)	0.03 (0.003)	1.09 (1.9)	4.2 (7.6)	—	14 (7.8)	16 (8.9)	19 (10.6)	—
	200C197	200 (119)	0 (0)	Basalt/ gravel	0.23 (963)	0.03 (0.003)	1.06 (1.8)	4.3 (7.7)	—	14 (7.8)	16 (8.9)	19 (10.6)	—

generally not detrimental to the stability of a structure, leakage through cracks can result in an undesirable loss of water, create operational or maintenance problems, and be aesthetically undesirable. Leakage through vertical cracks can be extremely difficult to stop or control without grouting, installation of external waterstops, or both. The best method of preventing leakage is to install stress relief (contraction) joints in the mass RCC before filling and either control leakage with embedded waterstops and drains, seal the cracks on the upstream facing, or use a membrane facing system.

With time, natural calcification will generally reduce seepage through minor cracks and lift joints.

#### 4.10—Durability

RCC, like conventional mass concrete, is prone to deterioration due to the effects of abrasion, freezing and thawing, and other factors such as alkali-aggregate reaction and sulfate attack.

**4.10.1 Abrasion erosion**—Abrasion erosion damage results from the abrasive effects of waterborne sediments, ice, and other debris impinging on the RCC during operation of a hydraulic structure (ACI 210R). Abrasion erosion resistance is primarily governed by compressive strength and quality of the aggregate. RCC pavements at heavy-duty facilities such as log storage yards and coal storage areas

have shown little wear from traffic and industrial abrasion under severe conditions. The North Fork Toutle River Debris Dam spillway showed only surface wear after being subjected to extraordinary flows of highly abrasive grit, timber, and boulders. This structure was constructed with RCC containing high-quality, small-size aggregate and a higher cement content than normally used in mass RCC construction (500 lb/yd<sup>3</sup> [300 kg/m<sup>3</sup>]).

Overflow spillways of RCC dams subjected to frequent use should generally be lined with high-quality conventional concrete to prevent abrasion erosion damage (refer to Section 5.8). The spillways at both Willow Creek and Galesville Dams do have exposed RCC flow surfaces. The rationale for not constructing conventional concrete-lined, overflow spillways was primarily based on cost and anticipated infrequent use. Spillway flows at Galesville Dam during 1996 and 1997 flooding, however, resulted in an irregular lower nappe (surface) that separated from the spillway face at some locations.

Some large-scale performance tests of lean mass RCC by the USACE at the Detroit Dam test flume showed good resistance to erosion (Schrader and Stefanakos 1995). Additional testing by USACE Los Angeles District using small samples showed excellent resistance to erosion (Omorieg et al. 1994). Abrasion tests performed in accordance with ASTM C1138 report the resistance to abrasion increased with increasing compressive strength and with the larger NMSA mixtures (Dolen 1999). RCC mixtures should have comparable erosion resistance to conventional concrete of similar strength and NMSA.

Low-head structures at Ocoee No. 2 and Kerrville Dams have been subjected to overtopping without the need for maintenance or repairs. The spillway at Ringtown No. 5 Dam in Pennsylvania has experienced flows on a frequent basis for over 10 years with only minimal deterioration. Caution is still suggested because high-velocity flows through RCC spillways have not yet been fully evaluated. Spillways subjected to frequent high-velocity flows are still typically faced with conventional concrete. USACE recommends that spillways with velocities exceeding 24 ft/s (7.3 m/s) or frequent flow that is likely to result in maintenance problems be lined with conventional concrete. ASTM C1138 has been used to evaluate the underwater abrasion resistance of both conventional concrete and RCC.

**4.10.2 Freezing and thawing**—RCC mixtures do not normally have intentionally entrained air, and consequently will not have a high freezing-and-thawing resistance in a critically saturated moisture condition. Many examples of good field performance exist, although RCC subjected to ASTM C666/C666M, Procedure A, typically performs very poorly. Large blocks of the Lost Creek RCC test fill totally deteriorated when exposed at mean tide level at Treat Island, ME, due to the combined action of salt water, major tidal fluctuations, wetting-and-drying cycles, and freezing and thawing. Large sections of air-entrained RCC exhibited improved performance after 2 years exposure at Treat Island (Day 2006).

Laboratory investigations and field applications have shown an air-entraining admixture can effectively establish an air-void system with good performance, even when subjected to ASTM 666/C666M testing. Air-entrained RCC samples showed improved freezing-and-thawing resistance compared with non-air-entrained RCC for Santa Cruz Dam mixtures (Dolen 1991). Microscopic evaluation of cores from full-scale field mixtures at Zintel Canyon Dam has shown satisfactory air-void systems and excellent freezing-and-thawing performance. Many mixtures require a high dosage of air-entraining admixture to be effective. Mixtures with clean aggregates, however, do not require a significant change in dosage rate (U.S. Bureau of Reclamation 1992).

#### 4.11—Density

The lack of entrained air and lower water content of many RCC mixtures results in a slightly higher density when compared to conventional air-entrained mass concrete made with the same aggregate. Fully compacted, non-air-entrained RCC has a low air content (generally 0.5 to 2.0%) and a low water content resulting in a density approximately 1 to 3% greater than conventional concrete and routinely exceeding 150 lb/ft<sup>3</sup> (2400 kg/m<sup>3</sup>). Air-entrained RCC will have a unit weight comparable to conventional concrete.

## CHAPTER 5—DESIGN OF ROLLER-COMPACTED CONCRETE DAMS

### 5.1—General

RCC offers a wide range of economical and safe design alternatives to conventional concrete and embankment dams. Placing RCC in lifts that are compacted by vibratory rollers, however, does not change the basic design concepts for dams, locks, or other massive structures. A detailed treatment of dam design principles and formulas is not addressed in this chapter. References and information sources for gravity dam design in general are available (U.S. Bureau of Reclamation 1976; USACE 1993, 1995a,b,c, 2003). This chapter focuses on unique design considerations for RCC dams. The information in this chapter presents the state of the art in the design of RCC dams and other massive structures. It is not purported to be the standard for design. Any organization or individual may adopt practices or design criteria that are different than the guidelines contained herein.

Important considerations that should be addressed before proceeding with detailed final designs include the basic purpose of the dam and the owner's requirements for cost, schedule, appearance, watertightness, operation, and maintenance. A review of these considerations should determine the selection of the proper RCC mixture, lift surface treatments, facing treatments, and the basic configuration of the dam. The overall design should focus on keeping construction as simple as possible to fully capture the advantages of rapid construction using RCC technology.

### 5.2—Foundation

The development of RCC technology, materials, and construction practices has led to a number of developments related to foundation conditions. Practices have also evolved

that could be detrimental to the quality of an RCC structure. Several are discussed as follows.

**5.2.1 Foundation quality**—Foundations that are suitable for conventional mass concrete are also suitable for RCC with similar properties. As discussed in Section 5.3, the low-cost construction techniques and material properties of RCC make it practical and economical to use a wider base and special design details to accommodate foundations that would otherwise be unsuitable. Examples include Concepcion, Big Haynes, Burton Gorge, Rompepicos, and Buckhorn Dams (Schrader 2006a,b).

Ground contours were widened in combination with other special details that allowed these projects to be placed on poor foundations for some, or all, of the length of the dams (Schrader 1999). Not all projects can accommodate these adjustments, and not all RCC dams can use otherwise unacceptable foundations. For example, the downstream terrain may not permit widening a dam section. Also, the foundations for some projects may have reasonable mass material properties with regard to strength, but they may have other serious issues such as potential piping, seepage, or planes of weakness that preclude concrete dams, including RCC.

RCC dams have been built with different widths at the base of adjacent monoliths to accommodate different foundation materials and support capacity. This has included sudden changes in base width at a monolith joint as well as tapering the base width to allow a variable slope of the downstream face such as at Concepcion Dam and Big Haynes Creek Dam. When adjacent monoliths might undergo differential movement or displacements due to different bearing areas or monolith heights, compressible materials, such as cork board or bitumen-impregnated board, is advisable along the full area of the monolith joint face to ensure that each block is independent. This allows movement of one monolith relative to the other monolith without transferring stresses from one side of the joint to the other side.

**5.2.2 Foundation shaping**—Foundation shaping should generally follow guidelines similar to those used for conventional concrete dams. This includes excavation of shear zones and inactive fault areas and filling with them with conventional concrete where RCC cannot be practically placed. RCC of the same quality to be used in the dam should be used wherever possible to fill irregularities and depressions.

If RCC cannot be practically placed in confined areas at the foundation, conventional concrete that approximates the RCC, or approximates the mass modulus of the foundation, should be used. This includes elastic properties as well as strength. Conventional concrete used for this purpose in dam construction is typically referred to as dental concrete. It is generally undesirable to place significant quantities of high-strength, high-modulus concrete in isolated locations scattered throughout a foundation with a low mass modulus. This is especially true if lower-strength RCC is to be used in the dam. In this case, the dental fill would be surrounded by lower-strength and low-modulus material.

If, on the other hand, both the foundation and RCC have higher strength and modulus typical of most conventional concrete, less attention is needed, except with regard to

thermal cracking as discussed in the following. When needed, suitable dental concrete mixture can usually be proportioned to achieve both lower strength and lower modulus. As with the dam itself, short-term strength is not an issue. The dental mixture should be based on long-term strength and properties, with a much lower interim short-term strength used for earlier-age quality-control cylinders.

Cracking has occurred in RCC above areas where a large amount of relatively strong dental concrete was placed in deep troughs. This is related both to the stiffness or modulus of the hardened concrete, as discussed previously, and to thermal cracking. If a deep placement of dental concrete is required, the mixture should ideally be precooled. If this is not practical, thermal cracking can usually be avoided by placing the dental concrete in thin lifts every 2 or 3 days and, if necessary, separating placements in a checkerboard layout with waterstops in joints that are allowed to cool individually before placing adjacent concrete. This generally does not apply where the distance from the center of the placement to the foundation less than approximately 3 ft (1 m) because heat can flow in three directions from the dental mixture to the foundation, and also in one direction to the atmosphere. Foundation shaping should avoid tall vertical or near-vertical steps that could propagate a crack upward in the RCC absent a mitigating control joint installed at the location. Where vertical, or near-vertical, steps are unavoidable (for example, at steep abutments that require benches), excavation lines should be adjusted where practical so that the step is located at a monolith joint, or the monolith joint should be adjusted to match the excavated step. Large longitudinal (parallel to the axis of the dam) steps in the foundation can normally be avoided with reasonable excavation planning and guidelines. Particular attention should be given to avoiding a continuous vertical step that extends longitudinally from one monolith joint to another, especially near regions of maximum thermal stress.

Localized vertical steps on the order of 3 to 6 ft (1 to 2 m) high may need to be laid back with a flattened slope. This is a normal requirement for embankment dams where differential settlement, as well as good compaction against the rock face, are legitimate concerns. Because RCC does not settle, and sealing to the rock is typically accomplished with bedding or conventional concrete placed concurrently with the RCC, these concerns are not applicable to RCC dams.

Vertical or near-vertical steps that are higher or longer than the aforementioned guidelines should generally be laid back to approximately 0.8 (H) to 1.0 (V) or flatter. This is more important when the RCC has strength and mass modulus properties greater than those of the foundation, and considerably less important when the properties of the foundation and the long-term properties of the RCC are similar. It is also less important when the RCC has low early-age modulus and strength, and high creep resulting in stress relaxation with time. In this case, the RCC can deform and accommodate abrupt irregularities in the foundation with little or no induced stress.

**5.2.3 Embedded structures**—Embedded structures may be permanent features of the design, such as outlet encasements

or features necessitated by construction means and methods. It is preferable to locate encased outlets or diversions so that they do not interfere with the general progress of RCC placement and do not initiate cracking within the dam itself. Embedded outlets placed in an excavated trench that is back-filled with dental concrete is ideal. A second preferred location is at the abutment contact, particularly if they are steep. Some RCC dams are constructed using a conveyor system, with the conveyor being supported on posts that require a substantial footing. Ideally, support posts should be constructed upstream of the face of the dam to avoid initiating cracks. If embedded in the dam, these footings represent fixed rigid blocks protruding into the dam with vertical faces that could initiate cracking. There are several alternatives to construct these footings to minimize crack potential, such as to use appurtenant structures like an intake tower, or to construct the footings upstream of the dam, recessed into the foundation, or at formed contraction joints.

Concrete (including RCC) ramps should also be avoided within the RCC, unless their impact on design issues including thermal stress/restraint and potential for propagation of a ramp face as a crack into the RCC is adequately addressed. If ramps are to be constructed and left in place, they should use RCC similar to the RCC in the dam, and the position of the ramp should usually be toward the middle of a monolith. Because of restraint, ramps on the foundation require more attention than ramps that are within the RCC, above the foundation.

**5.2.4 Leveling concrete**—Some RCC projects have used leveling concrete to cover the foundation and provide a smooth base from which to start RCC, whereas other projects start with RCC directly on the foundation. There are arguments for and against each approach, with each being more or less suitable to different conditions.

Leveling concrete simplifies the start of RCC placing and its initial production rate, but it requires considerable time to construct, uses concrete that is more expensive than RCC, and may have different properties than the RCC. If the RCC, foundation, or both have a high mass modulus similar to traditional concrete, leveling is simply another material with properties similar to what is above or below it. If conventional concrete is used for leveling a foundation with substantial undulations and slopes, it may be very thick and require controls to minimize cracking from thermal or drying shrinkage. If foundation excavation and treatment are performed before RCC, leveling concrete may be performed without interrupting RCC construction.

Formed vertical and clearly defined joints should be avoided in leveling concrete unless they have waterstops and/or coincide with contraction joints in the RCC or are grouted. This applies to both the transverse and longitudinal directions. A formed joint represents the start of a crack off of the foundation and a stress riser (restraint) where thermal stresses are usually at their maximum. Some projects that have used leveling concrete and could not avoid extra joints due to concrete plant and placing capacity issues have epoxy-injected the joints after they opened and before placing RCC.

The trend in RCC dam construction is to minimize the amount of leveling concrete by using a bedding concrete placed just before the RCC by first spreading a thin layer of high-slump bedding mixture (with or without coarse aggregate) onto the rock, and then spreading the RCC over the bedding and compacting it while the bedding is still fresh. This has been one of the most common procedures for placing RCC on foundations, and it has been very successful. The RCC compacts into the bedding so the two materials become one concrete, while the grout and mortar portion of the bedding bond to the rock. There is no distinctly different material between the foundation and RCC. This avoids the separate leveling mixture and its concerns.

If the foundation is relatively poor, and it would deteriorate from exposure before placing RCC, it is common to use shotcrete or a thin mud mat to seal and protect it. This is typically approximately 2 to 4 in. (50 to 100 mm) thick for shotcrete and 4 to 6 in. (100 to 150 mm) thick for a mud mat. Clearly defined formed edges should be avoided. The material will be subject to some cracking, but it will be random. By keeping the mud mat thin, cracks will likely mirror the joints in the foundation rock. Where shotcrete is placed against abutments, and there is a tendency for the foundation underneath to still deteriorate, or where the abutment cannot be cleaned to sound material before shotcreting, grout pipes can be used to ensure a seal between the shotcrete and foundation. The grout pipes are individual lines, usually PVC, that are routed through the dam to a convenient location, such as the downstream face, for later grouting. It is imperative to maintain identification of each pipe so that they can be grouted in a planned pattern after the RCC has been placed to a substantial height above the location.

### 5.3—Dam section considerations

The design of an RCC structure balances the use of available materials, the selection of structural features, and the proposed methods of construction. Each method should be considered within the context of the other factors. For example, a dam section may require certain shear strength for stability, the available materials may not be capable of providing those strengths, or the specified construction method may not ensure that the lift-joint quality is sufficient to provide the required shear strength. Mixture proportion changes, construction method changes, or a revised section discussed in Section 5.2 may be the solution.

RCC dams can be constructed with straight or curved axes, with vertical or inclined upstream faces, and with downstream faces varying from vertical to any slope that are economically and structurally appropriate for a given site. The adopted design criteria, proposed height, and foundation characteristics strongly influence the basic dam cross section (Tarbox and Hansen 1988). The basic gravity section shown in Fig. 5.1, with a vertical upstream face, constant downstream slope, and a vertical downstream face at the top of the dam, has been used for many RCC dams. The low cost of RCC often makes it reasonable to flatten the downstream slope and add more mass than with conventional concrete dams. This reduces foundation stress, RCC strength requirements, and

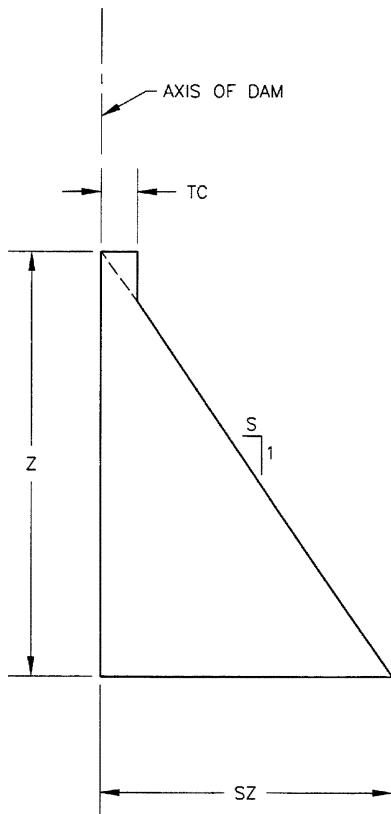

Fig. 5.1—Typical RCC dam section.

lift joint concerns. Reductions in cement content with the related reduction in unit cost and reduction in thermal stresses result. The possibility of using higher paste contents with higher strengths should also be investigated if the thermal stresses can be tolerated and the volume reduction of RCC and foundation excavation and treatment offsets the increase in cost due to higher unit costs of the RCC. Influencing factors include the length of diversion, the cost and availability of cement and pozzolan, the quality and production costs of the aggregates, foundation quality, and hazard rating of the structure.

The width of the top of dam should be established after consideration of several factors, including the cost of additional RCC and downstream vertical facing, required width for access during operation and construction, inertia (seismic loading) of the laterally unsupported top section of the dam, the effect of the mass on sliding stability due to the added confining load, the effect of the mass on the location of the resultant force for the entire section, the distribution of foundation stresses, and the possibility of causing tensile stress across downstream lift joints for a high dam in the reservoir empty condition.

Incorporation of a vertical downstream face near the crest intersecting a sloped downstream face below results in a chimney section. The feature can result in significant material savings in the required volume of RCC; however, it can result in higher stresses, and because of the limited work area, results in much lower RCC placement rates. For dams exposed to significant seismic loads, a straight downstream

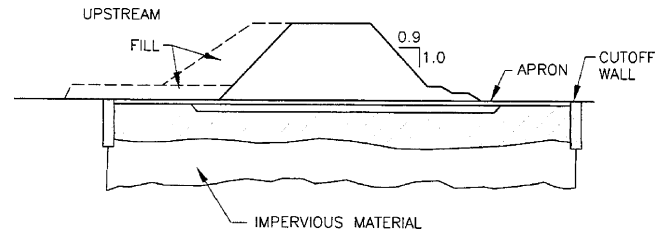

Fig. 5.2—Typical low RCC dam section for nonrock foundation.

slope from the crest to the foundation eliminates the potential for stress concentration cracking.

A parapet wall on the top of the dam will act as a personnel barrier and curb. Parapet walls can be constructed with conventional reinforced concrete or by extending precast panels. The wall can be a continuation of upstream precast panels if that option is used to form the upstream face of the dam.

Small RCC dams on pervious or soil foundations require special design considerations. Designs should consider differential settlement, seepage, piping, and erosion at the downstream toe. Foundations of this type usually require one or more special measures, such as upstream and downstream aprons, grouting, cutoff walls, and drainage systems. A basic gravity dam design configuration for a low dam on a weak foundation or for dams on soil foundations is shown in Fig. 5.2 (Londe and Lino 1992).

## 5.4—Stress and stability analyses

**5.4.1 Methods to analyze stress and stability**—Approaches to stress and stability analysis for RCC dams are similar to those used for conventional concrete structures, with added emphasis on tensile strength and shear properties of the horizontal lift joints, and consideration for beneficial stress redistribution when the RCC has a proven nonlinear stress-strain behavior with strain softening.

Some projects have oriented lift joints with an upstream dip of approximately 5 degrees or more to facilitate drainage of their surfaces during construction. The stability benefit of this upstream dip is limited. Its contribution to shear resistance is approximately equal to adding the slope to the friction angle. Several projects have installed lifts with a downstream slope, also to facilitate cleaning operations. In a similar manner, the friction angle is decreased by the slope.

A static stress analysis is often performed for the initial design of an RCC dam. For dams in wide canyons, or with contraction joints that will be open, the two-dimensional gravity or finite element method of analysis is adequate to calculate stresses. More complex methods of analysis, such as the trial-load twist method and three-dimensional finite element method, have been used for dams located in narrow V-shaped canyons. For dams located in seismically active areas, a dynamic stability analysis is often necessary using either a two- or three-dimensional finite element method, whichever is appropriate for the canyon shape. Recommended safety factors to be applied for the complete range of loading conditions from static through dynamic loads are generally



similar among various international authorities, but they vary somewhat depending on the authority and the thoroughness of analysis.

**5.4.2 Shear-friction factor**—The following discussion relates to shear within the RCC dam. Shear and stability of the foundation should be evaluated as a foundation issue, as it is for traditional concrete dams.

As in a conventional concrete gravity section, resistance to sliding within the RCC section is dependent on the cohesion of the concrete, the compressive stress on the potential failure plane, and the coefficient of sliding friction along the failure plane. Shear through the mass should be considered, especially if there are thinned sections in the mass, such as at an extended toe, but the typical controlling shear plane will be along the weakest lift joint relative to applied sliding force, as it is for traditional concrete dams. RCC has many more lift surfaces than traditional mass concrete, and RCC is more likely to have low cohesion at the lift surface than traditionally placed concrete (especially with leaner mixtures and with excessive lift joint maturity), so the probability of at least some weak lift surfaces can be greater with RCC. This is minimized through proper mixture proportioning, construction equipment and construction procedures, retarders (to prevent forming of a cold joint), and diligent inspection.

The shear-friction factor (SFF) is a measure of the stability of a dam against sliding. The SFF on a horizontal plane is expressed as

$$SFF = (cA + (N - U)\tan\phi)/T$$

where  $c$  is the unit cohesion;  $A$  is the area of cross section;  $N$  is the component of confining force normal to the sliding surface;  $U$  is the uplift force acting on cross section;  $\phi$  is the angle of sliding friction; and  $T$  is the driving force parallel to the sliding surface.

The cohesion component of sliding shear resistance along lift joints is very sensitive to cementitious content and quality, construction quality, rate of placement and set time of the mixture, and lift joint maturity (Schrader 1999). Both cohesion and friction resistance are affected by compaction at the lift line, regardless of the cementitious materials content and parent strength of the compacted mixture.

Most design criteria require a minimum shear-friction factor of safety (SFFS) against sliding of 2 to 4 based on normal high headwater and low tailwater conditions, from 1.5 to 2 under flood conditions, and greater than 1.0 for seismic loads. Although it is not considered by most codes and authorities, a safe criteria for stability of an RCC dam is that the factor of safety against sliding greater than 1.0 for all load conditions using a cohesion value of zero, and a realistic residual friction angle after sliding, with realistic uplift for unbonded lift joints, should be considered. Precedents for this exist, with the most notable being the Saluda Dam (Schrader and Rizzo 2003). The average compacted in-place density at the time of construction is suitable for computing the vertical weight.

Shear properties at lift surfaces are dependent on a number of factors including mixture properties, joint preparation,

time from mixing to compaction, and exposure conditions. Actual values used in final designs should be based on tests of the materials to be used or estimated from tests on RCC mixtures from other projects with similar aggregates, cementitious materials content, aggregate grading, and joint preparation. As with any dam design, the designer of RCC structures should be confident that design assumptions are realistically achievable with the construction conditions anticipated and the materials available. Joint shear strength and sample data are discussed more in Chapters 4 and 6, and in various references (Schrader 1999; USACE 1995a; Electric Power Research Institute 1986; McLean and Pierce 1988; Boggs and Richardson 1985; Tayabji and Okamoto 1987).

For initial planning and design purposes, a value of lift joint cohesion of 5% of the design compressive strength with a coefficient of friction of 1.0 (corresponding to a  $\phi$  angle of 45 degrees) is generally used. Cohesion tends to be slightly lower for dry consistency RCC mixtures and slightly higher for wetter consistency mixtures. Where bedding mixture is used, the cohesion value will be essentially the cohesion value of the unjointed RCC mass. This normally approximates at least 10% of the compressive strength of the unjointed RCC.

**5.4.3 Determining design values for shear**—Design values for shear strength parameters at lift joints can be determined in several ways. Drilled cores can be removed from RCC test placements and tested. Individual specimens can be laboratory fabricated with simulated lift joints if the mixture is of a consistency and the aggregate is of a size that permits representative individual samples to be fabricated, but care is needed to realistically correlate laboratory prepared samples to what will actually be achieved in the field.

At a number of RCC projects, joint shear tests have been performed on a series of large blocks of the total RCC mixture cut from test placements compacted with full-scale equipment or walk-behind rollers that simulate the energy of a large roller. Various joint maturities and surface conditions of the actual mixture for the project are evaluated and used to confirm or modify the design and construction controls. Due to the unique nature of the design criterion, a comprehensive series of tests was done for Saluda Dam where the design was based on residual shear strength after cracking and sliding (Schrader and Rizzo 2003).

In-place direct shear tests have been performed at various confining loads on blocks cut into field placements made with full production equipment and procedures. All shear tests for RCC are delicate and unique. They require experienced personnel, special equipment, and special procedures, but in-place tests are probably the most difficult as they require extra care and attention to detail.

Shear property estimates and shear analyses should take into account several key factors:

- It is not reasonable that an isolated section of an RCC dam would slide away, leaving behind another portion of the dam that remains bonded at a lift joint. Consequently, over-reaction should be avoided if a finite element method analysis indicates that shear stress exceeds shear strength (with appropriate factor of safety) for a small portion of a large lift surface;

- Estimated shear strengths should include appropriate consideration for a reasonable amount of unbonded area to be expected on lift joints;
- When a back-analysis is performed using results of cores or shear blocks extracted from a dam, the percentage of unbonded lift joints should be considered. An unbonded lift joint will typically have the same friction as bonded joints, but it has no cohesion or tensile capacity. After excluding cores that were definitively broken by coring or handling, the remainder of unbonded cores should be assigned a value for apparent cohesion in sliding calculations; and
- One unacceptable lift joint is all that is required for failure. It is inappropriate to average good values from adjacent lifts with bad values from a clearly identifiable bad lift joint.

**5.4.4 Strain softening and stress redistribution**—RCC mixtures, especially those with low-early or long-term strengths, tend to have nonlinear stress-strain behavior with strain softening. That is, at increasing levels of stress, the material deforms or strains more than it does for the same unit increase in stress at a lower stress level. Strain softening occurs similarly in both tension and compression. This can have the very beneficial effect of decreasing peak stresses that would otherwise occur in isolated areas such as at the toe or heel of a high dam, and at other stress concentrations. As deformation in the area of high stress increases with increasing load, very little added stress occurs. Instead, most of the stress that would have been added to this area if the concrete had linear elastic properties is redistributed to adjacent areas of lower stress. An example of this, including reductions in peak stress for the nonlinear properties of RCC at Mujib Dam, can be found in Schrader and Rashed (2002).

**5.4.5 Uplift and upstream watertightness**—Proper estimates of uplift within the dam are essential, regardless of whether it is constructed with traditional mass concrete or RCC. Recent practice and industry guidelines have established that, rather than using past practice of assuming 100% uplift at the upstream face and 67% reduction of uplift at the drilled drains, the designer should carefully evaluate imperviousness at the upstream face based on precedent for the method being used to establish watertightness on each project. If the procedure to be used, with the anticipated degree of quality control, has demonstrated that uplift will be less than 100% near the upstream face, it is appropriate to use this reduced uplift in the stress and stability analysis. An example is a dam design with a proper impervious upstream watertight barrier with face drains. When properly designed and installed, this approach has achieved total control of uplift pressures at the upstream face. A conservative approach for this type of system has been to assume 50% uplift reduction at the upstream face, with 67% additional reduction at drilled drains. A significant improvement in stability and reduction of heel stresses can result (Schrader and Rashed 2002).

Many RCC dams are constructed with stair-stepped spillways using conventional concrete for the steps. The horizontal lift joint surface between steps is typically not watertight. Any lift joint seepage that migrates to the down-

stream face can normally escape out along the lift joint. In some cases, half-round drains have been installed through the steps to assure that uplift pressure can escape. If the pressure cannot escape (for example, if a continuous slab of concrete is used to create a smooth conventional spillway over the RCC), uplift is trapped on the RCC lift joint behind the slab. The design should address the implications of this potential increased uplift both within the mass and against the spillway slab, or drainage should be provided under the slab.

**5.4.6 Tensile strength**—Lift-joint bonding is of interest from the perspectives of tensile strength (usually under earthquake load), cohesion for sliding resistance, and watertightness. Tests of various concrete mixtures have shown that the dynamic or fast load strength applicable to earthquakes is higher, with the dynamic increase factor (DIF) being greater for faster loads and for lower-strength concrete and lower for slower loads and higher-strength concrete. Low cementitious-content RCC with drier consistency (Vebe times greater than approximately 45 seconds) typically has a low lift-joint tensile strength in most of the dam with no special joint treatment. Although it varies from project to project, with lift joint maturity and with the degree of inspection, the overall long-term average lift-joint strength for these types of mixtures tends to be on the order of approximately 30 to 80% of the unjointed RCC tensile strength.

**5.4.7 Additional considerations for lift joints**—To achieve shear properties approaching that of parent or unjointed concrete, it is critical that lifts be placed before set of the underlying lift occurs. Highly workable RCC with high proportions of cementitious materials can achieve high shear performance without supplemental bedding mortar only if placement is done on surfaces that have not yet set. Many factors contribute to the setting characteristics of RCC surfaces in field conditions.

RCC mixtures that exhibit bleeding of mixture water contain more water than is necessary for optimum performance. Water contents should not extend into this range. Eliminating the occurrence of bleed water in the mixture is one of the purposes of trial mixing. The water content of the mixture is dependent on the characteristics of the constituent materials, primarily the quality of the aggregate fines and the pozzolanic materials. The occurrence of bleed water can result in the deposition of laitance on the surface of the RCC lift. In sufficient quantity, laitance can seriously degrade the shear performance of the lift. One example of such phenomenon is during recent evaluations of density, compaction, and lift joint quality at the Saluda Dam test section. One set of saw-cut blocks was removed for testing unbonded where there was just slight evidence of laitance. This occurred at the surface of mixtures with lower Vebe times and mixtures that tended to bleed. No other test blocks separated at the lift. Mixtures of this nature should be reportioned to eliminate this problem.

## 5.5—Temperature studies and control

RCC dams are a series of one or more unreinforced massive concrete monoliths. The design of the structure should include provisions for dealing with inherent temperature changes and resulting volume changes. These volume

changes lead to cracking of the structure. The principal concerns for cracking in RCC and other gravity dams are structural stability, appearance, durability, and leakage control. Although not a factor in the stability of a structure, uncontrolled leakage through transverse cracks can result in an undesirable loss of water, create operational or maintenance problems, and be visually undesirable. Leakage is extremely difficult to control.

Thermal stresses and associated volume changes typically result in transverse cracking of the structure. RCC dams experiencing high thermal stresses may also exhibit unseen cracking parallel to the axis of the dam. This type of cracking has occurred in both conventional and RCC dams. It can have serious structural and stability implications. The dam will probably be safe and stable for normal load conditions, especially if the crack is closed and does not contain water. Analyses of different dams have shown that this type of cracking can jeopardize sliding and overturning stability if it fills with water at the reservoir head. The source of water can be the foundation, seepage through lift joints, monolith joints with failed waterstops, or transverse cracks.

Details of comprehensive temperature evaluations unique to RCC are discussed in U.S. Bureau of Reclamation (2005), USACE (1997), Tatro and Schrader (1985, 1992), and Ditchey and Schrader (1988).

Many factors can be evaluated when attempting to predict the degree of cracking a structure may experience. Simple analyses that combine very generalized conditions yield very general results. Complex analyses combine very specific determination of conditions to yield more exacting results. As a minimum, designers should consider the daily and monthly ambient temperature fluctuations, the conditions in aggregate production and RCC mixing that lead to an RCC placing temperature, a realistic placing schedule, and realistic material properties. In many cases, the results of a thermal study are key to determining mixture proportions, construction schedule, cooling requirements, and jointing requirements.

Specific actions can be effective in minimizing thermal stresses. These include substitution of pozzolan for some of the cement, limiting placement of RCC to the season when cool weather is expected, placing at night, lowering the placing temperature, and jointing. When the option is available, selecting an aggregate of low elastic modulus and low coefficient of thermal expansion is helpful. Post-cooling options that have been effective for RCC are discussed in ACI 207.4R.

It is difficult to generalize the cracking performance of a structure. The exposure of relatively thin lifts of RCC during initial hydration may contribute to an increase or decrease in peak temperatures depending on ambient conditions and the length of exposure. Each situation should be separately and carefully evaluated. For example:

1. While placing RCC during a hot time period, the surface absorbs heat from the sun, which increases the temperature of the mixture and increases the rate at which hydration is generated. The longer the surface is exposed, the more solar energy is absorbed, which will produce a higher peak internal temperature. Faster

placement in this situation will help reduce internal temperatures; and

2. Placing during the cooler time of year can allow completion of a project before the heat of summer. Under these conditions, materials are naturally pre-cooled, resulting in lower placing temperatures and, consequently, lower peak temperatures, than if placed in warmer periods. If the time interval until placement of the next lift is long, some of the early heat from hydration can be dissipated to the atmosphere. If the peak temperature does not occur before placement of the next lift, faster placing can have the detrimental effect of increasing the internal temperatures.

Various analytical methods, ranging from hand computations to more sophisticated finite element methods, are available to provide an estimate of the temperature and stress or strain distributions throughout a structure. Comprehensive, state-of-the-art analyses account for the time-dependent effects of temperature, including adiabatic heat rise, ambient climatic conditions, simulated construction operations, and time-variant material properties (Tatro 1999).

## 5.6—Contraction joints and cracks

The principal function of vertical contraction joints is to control cracking due to foundation restraint, foundation geometry, and thermal volume change. Drying shrinkage occurs at the surface of exposed mass concrete, but it does not occur to depth in most massive structures such as dams. Contraction joints have also been used as formed construction joints that divide the dam into separate independent work areas or monoliths. Depending on the mixture, climate, and approach to design, some RCC projects have included many contraction joints, while others have had no contraction joints.

The main concerns for cracking in massive gravity sections are structural stability, appearance, durability, and leakage control. Seepage through transverse upstream to downstream cracks and joints can result in uncontrolled leakage and an undesirable loss of water. It can also create operational or maintenance problems, and be visually undesirable. This normally does not create a direct stress and stability concern, but if leakage enters a crack or monolith joint and then traverses out onto lift joints, it can cause uplift conditions that were not part of the design. This can result in compromised safety factors.

Seepage into longitudinal cracks, parallel to the axis of the dam, is more likely to be serious. If water under reservoir or abutment groundwater pressure fills a longitudinal crack, it can dramatically affect sliding and overturning stability. The consequences can be catastrophic. These types of cracks, and their impact on dams, have occurred in both conventional and RCC structures, and their potential consequences have been demonstrated. Remedial measures typically include draining hydrostatic pressure from within the crack with a comprehensive series of drilled drain holes. Even with drainage, the mass upstream of the crack may not be effective, and the impact on stability can be serious, if not catastrophic. Some longitudinal cracking has required grouting and post-tensioning across the crack, but this is not very practical

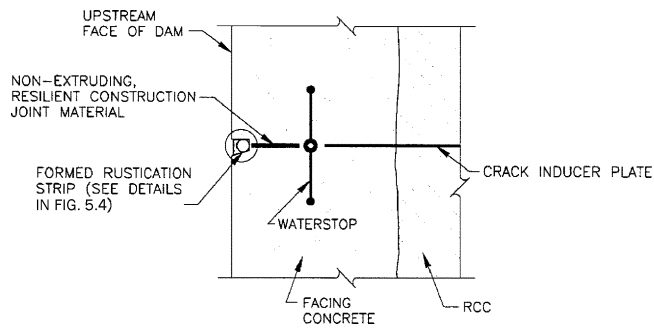

Fig. 5.3—Contraction joint detail.

unless the reservoir can be drained or lowered (for example, in a navigation lock outage).

When thermal or other analysis indicates that an unacceptable longitudinal crack is possible, a groutable joint can be constructed at the location in question. The joint should be grouted after thermal contraction has caused the joint to open significantly, but grouting may be needed earlier due to the schedule for raising the reservoir. In this case, a regroutable joint should be designed if possible, or the joint and grout should be designed so that it will continually expand over time as the joint tends to open more.

The location and spacing of joints depends on foundation restraint, temperature change, the time period over which it occurs, the tensile strain capacity of the concrete at the time in question, creep relaxation, the coefficient of thermal expansion of the concrete, and applied loads. For many projects, joints are carefully formed to go through the entire dam to induce cracks. Other designs use partial joints to provide a weakened plane along which cracks will propagate. Waterstops and drains are usually an integral part of a complete joint design. Chapter 6 provides various methods for installing transverse joints and joint drains.

Seepage control methods of transverse contraction joints vary widely. Seepage control methods for RCC dams have included: 1) a surface control joint with waterstop; 2) a surface control joint with waterstops and grout taken; 3) membrane placed over the upstream (either a membrane placed with precast concrete ponds or an exposed membrane); and 4) conventional concrete face of jointed slabs placed after the RCC.

Transverse contraction joints with surface control and waterstop have been used in numerous RCC dams. Typical details consist of a formed crack inducer in the upstream face with a waterstop in the facing concrete, as shown in Fig. 5.3 and 5.4, followed by crack inducement in the RCC lift by one of the methods described previously. For water-retaining structures, induced contraction joints are recommended. Thermal and foundation related cracks at Upper Stillwater Dam caused significant leakage that required post-construction grouting and subsequent repairs.

Arch dams require contact across transverse contraction joints for the structure to function in the three-dimensional manner that it has been designed. This normally requires grouting with effective grout stops at both the upstream and downstream faces of the dam, similar to conventional arch concrete dams. Unlike arch dams, RCC is typically not post-

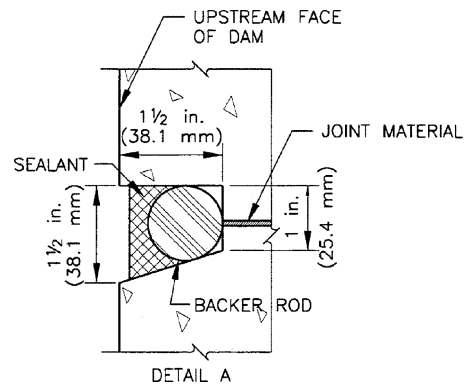

Fig. 5.4—Contraction joint seal at upstream face.

cooled to ensure full contraction before grouting, so the concerns discussed previously for longitudinal joints also apply to these joints. In some instances, if thermal contraction is kept to a minimum, joints in the lower portion of the dam may remain in close contact, even without grouting. The same applies to straight-axis dams in tight V-shaped canyons that can also benefit from three-dimensional effects similar to arch dams. The details of contraction joint opening (or not), grouting, and three-dimensional benefits need to be evaluated much more carefully for RCC dams than for conventional dams.

### 5.7—Galleries and drainage

Galleries and adits serve the same purposes in RCC dams as they do in conventional concrete dams. A foundation gallery serves as access to the interior of the dam for drilling or re-drilling foundation grout curtain and drain holes, grouting the foundation, inspections, seepage collection, access for instrumentation and other equipment, and a terminal point for drain holes drilled from the crest or into the foundation. Of course, if foundation grouting is done from an upstream cutoff wall or plinth slab, as it is for concrete-faced rockfill dams and RCC dams with an impervious upstream face, the primary purpose of the gallery is eliminated.

Generally, RCC dams less than approximately 100 ft (31 m) high have not needed or used galleries, whereas higher dams generally have included galleries, particularly if they are water-storage dams versus low-pool, flood-retention dams. If internal drainage is needed or desired in a low dam, a simple approach has been to place free-draining coarse aggregate approximately three lifts high at the location where a gallery would otherwise be located (Schrader 2002). Drains are then drilled from the top of RCC or top of the dam, through the aggregate drain, and into the foundation. The aggregate drain discharges to the downstream face. By making the aggregate drain large enough, it can always be excavated to create a gallery if this becomes necessary in the future. Galleries are an obstacle to rapid and efficient placement of RCC. Safety during construction is also affected due to the confined work area, as is the quality of RCC that can be placed in the restricted area between the upstream face and the gallery. In lifts with galleries, RCC placement efficiency is always less than it would be absent the gallery. In particularly

large lifts relative to the exposed gallery, placement efficiency may remain quite high, perhaps as much as 90%, depending on placement means and methods. For placements where the gallery exposure is a much larger component of the lift's width or area, efficiencies drop significantly in cases well below 50%.

A variety of methods have been used to construct galleries. Examples include filling the gallery area with uncemented aggregate or sand and excavating it out later as the RCC is placed above; placing RCC at the gallery location and then removing it with an excavator; using precast panels for the walls, ceiling, or both; and using conventional forms with or without conventional concrete against the forms. The designer should consider the performance and operational needs, aesthetics, and cost of construction (including the reduction in RCC production) associated with the construction of galleries.

Using a bedding mixture between lifts, or a high cementitious-content RCC, is suggested upstream of galleries and between the first three layers in the area above and below the gallery floor and ceiling. This provides watertightness, bond against uplift below the floor, and added sliding resistance against reservoir pressure at the upstream gallery wall.

Shallow blanket grouting can be performed on the foundation surface before RCC placement. Other foundation drilling and grouting can be performed from a gallery. The gallery should be large enough to accommodate suitable production equipment, especially at interior corners and intersections.

Internal drains can be easily drilled with track-mounted rotary or rotary percussion equipment. Nominal 3 in. (75 mm) size holes at approximately 10 to 15 ft (3 to 4.5 m) spacing is adequate. While some may argue a potential for plugging drainage paths with residual cuttings after cleaning, percussion holes can be drilled at high production rates with accuracy on the order of  $\pm 3$  ft (1 m) in approximately 120 ft (37 m). A very efficient way to drill these holes is immediately after placing the RCC lift that is the gallery floor. By designing a long gallery with holes starting at the same elevation, it has been effective to stop RCC for a short time while track drills access the lift and drill the holes. The area is then cleaned, treated as a cold joint, and RCC placing resumes.

Where longitudinal joints exist, they can be grouted from a gallery or from outside of the dam. A practical way to make this joint simply is to place open graded coarse aggregate at the joint location as each RCC lift is spread. The RCC is then compacted with the aggregate. Grout tubes are installed in the aggregate as it is placed. Before raising the reservoir, but after sufficient cooling of the mass, the joint is pressure grouted from the bottom up with expansive grout. A continuous monolithic concrete mass results instead of two masses connected by a thin grout line.

### 5.8—Facing design and seepage control

The upstream and downstream faces of RCC dams can be constructed by various means (Schrader 1985, 1993). The purpose of facings may be to control the seepage of water through the RCC lift joints, provide a surface that is resistant to freezing and thawing, provide a surface that is durable against spillway flows, provide a means to construct a face

steeper than the natural angle of repose of the RCC, and provide an aesthetically pleasing surface. Seepage may also be controlled by other methods.

The upstream face of the dam can be designed using any of a number of options. The most common approaches are vertical faces formed with temporary formwork and conventional facing concrete, internally vibrated (grout-enriched) RCC, and stay-in-place forms using precast concrete panels. These systems may incorporate PVC membranes or internal waterstops at joint locations.

The downstream face of the dam can be designed using a number of options. The most common approaches are the formed stair-stepped conventional concrete face and the unformed RCC surface. Step sizes may vary. Relatively smooth unformed spillways and downstream faces have been constructed by mechanically or manually trimming the RCC exposed face.

The following facing methods have been used for facing RCC structures, and each is discussed in more detail as follows and is summarized in Fig. 5.5 and 5.6.

Facing system	Applicability
Natural RCC face	Only for sloped RCC surfaces greater than 0.8H:1V
RCC against forms	Vertical, sloped, and stepped faces
RCC and bedding mortar against forms	Vertical, sloped, and stepped faces
RCC and GERCC against forms	Vertical, sloped, and stepped faces
RCC against forms with membrane	Vertical faces
RCC against slipformed panel	Vertical, sloped, and stepped faces
RCC against anchored precast panels	Vertical, sloped, and stepped faces
RCC against anchored precast panels with membrane	Vertical faces
RCC cast concurrently with conventional concrete facing	Vertical, sloped, and stepped faces
RCC with lagging anchored cast-in-place conventional concrete	Vertical, sloped, and stepped faces
RCC with lagging anchored slipformed conventional concrete	Vertical, sloped, and stepped faces

**5.8.1 Natural RCC face**—This facing option may be the simplest facing method. RCC is spread to the design line, and the face is the natural slope of the material. It requires no formwork and no special treatments other than perhaps compaction of the unformed joint edge. It may result in an overbuilt section and, depending on the skill of the dozer operator, may result in a significant loss of material during spreading. This facing option is only appropriate for sloped faces that are 0.8V:1H or flatter. If the joint face has not been compacted, trimming the RCC surface following placement is often done to remove loose or poorly consolidated material or improve the appearance of the surface.

**5.8.2 RCC against formwork**—RCC can be placed directly against formwork (Fig. 5.5(b)). The formwork is effective in controlling the volume and shape of RCC. The surface appearance of the resulting RCC face depends on workability of the RCC mixture and the extent of compaction

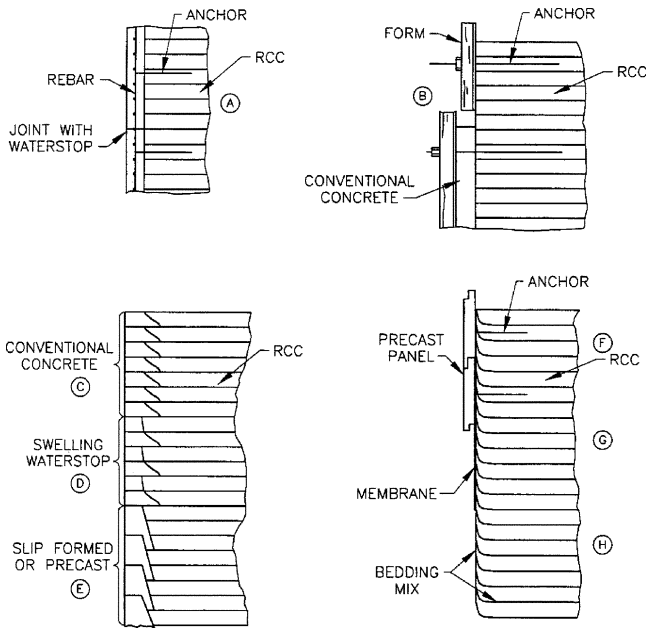

Fig. 5.5—Upstream facing options.

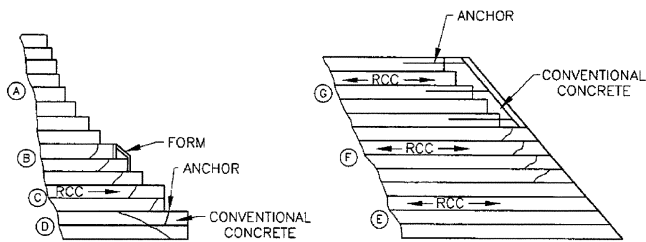

Fig. 5.6—Downstream facing options.

effort near the form surface. Excellent results have been achieved on several projects. Unfortunately, sufficient care is not usually taken in the placement of this system, and it is generally prone to poor appearance. The freezing-and-thawing resistance of this system is not good, and should only be used in protected areas or temperate climates. Form movement is a concern when placing RCC directly against external forming systems unless it is grout enriched and internally vibrated.

**5.8.3 RCC and bedding mortar against forms**—The addition of bedding mortar between the RCC and against the form surface provides several improvements. It provides a barrier to water that may seep along a lift surface that is inadequately compacted or has accumulated segregated aggregate. The bedding mortar fills voids at the form surface, resulting in a more conventional concrete appearance. The resulting appearance can be good. The freezing-and-thawing resistance of this system is not good, and should only be used in protected areas or in temperate climates.

**5.8.4 RCC with GERCC against forms**—When cement grout is placed in sufficient quantity on the RCC surface along the formed face and the RCC is of sufficient workability, it is possible that the affected area can be consolidated with internal vibrators. This is termed grout-enriched roller-

compacted concrete (GERCC). The practice varies from placing grout on the previous lift and covering with fresh RCC, placing the fresh RCC with the grout on top, or both. The goal is to place a sufficient quantity of high-quality grout to modify the no-slump RCC to a consistency suitable for internal vibrators. This system results in a very good surface appearance with less placement impacts than placing conventional concrete at the face. The freezing-and-thawing resistance of this system is not good, and should only be used in protected areas or temperate climates.

**5.8.5 RCC against forms with membrane**—The previous facing systems can be further modified to include a PVC membrane. Membranes have been installed on the vertical formwork surfaces against which RCC is placed. The forms are removed and the membrane is left in place. It is more common, and often more practical, to install such a membrane after the RCC has been placed to avoid production impacts of concurrent membrane installation.

**5.8.6 RCC against slipformed concrete element**—Interlocking slipformed stay-in-place elements have been used to create a permanent face (Fig. 5.5(e)). Slipformed concrete has been used on several projects to provide a high-quality concrete facing cast hours ahead of the RCC placement. After several hours, the interlocking curb elements are strong enough to serve as a form for the RCC yet young enough to maximize the bond between the RCC and the curb element. This system is ideal for projects where long continuous placements allow a slipform operation to move efficiently and where the rate of rise of RCC structure is approximately 3 ft (1 m) or less per day and does not overwhelm the slipform operation.

**5.8.7 RCC against anchored precast panels**—Another stay-in-place forming system uses precast concrete panels as forms (Fig. 5.5(f)). The precast concrete panels are placed and braced with either external form supports or braced against adjacent staggered panels. The latter system can depend on tieback anchors to provide the lateral stability. All precast panel systems use internal anchors as the permanent means to attach the panels to the RCC.

**5.8.8 RCC against anchored precast panels with membrane**—Precast panels make an attractive, economical, and crack-free face, but the panel joints are not watertight (Fig. 5.5(f)). Watertightness has been provided with a membrane of polyvinyl chloride (PVC) or polyethylene attached to the back of each panel. A pressure connection with epoxy has been used to provide a watertight seal where the anchors penetrate the membrane. The joints between panels need to be heat-welded to produce the impermeable face. Drains can be installed in the RCC to collect seepage.

There are two documented cases in the U.S. (Penn Forest Dam and Hunting Run Dam) where panels with attached membranes failed during construction. Rain, curing water, or a combination of both seeped between the membrane and the RCC. The hydrostatic pressures caused the panel anchor rod inserts to fail, allowing the panel to move away from the dam and thereby rupturing the membrane. Paradise Dam (formally Burnett Dam) in Australia had panel damage during a drawdown of the reservoir.

**5.8.9 RCC cast concurrently with consolidated concrete facing**—If a conventional concrete appearance or added durability is desired, conventional concrete can be used for the facing (Fig. 5.5(c) and (d)). A common method of constructing a conventional concrete face is to concurrently place the RCC with the facing concrete. No anchors or reinforcement other than that necessary to stabilize formwork are used to anchor the facing concrete to the RCC (Fig. 5.5(c)). Crack control of the facing mixture can be provided by water-stopped or sealed vertical contraction joints spaced appropriately for the mixture and exposure conditions. Typically, this is approximately every 16 to 30 ft (5 to 10 m). The thickness, or width (upstream to downstream), of a conventional concrete face varies from 1 to 3 ft (0.3 to 0.9 m). For thicker facings, the designer should consider the effect the extra mass has on temperatures, thermal contraction of the RCC and facing, and the contraction joint spacing.

**5.8.10 RCC with lagging anchored cast-in-place concrete**—Figure 5.5(a) and (b) are reinforced conventional concrete facings placed after the RCC has been placed. This is similar in concept to the concrete facing on the sloped face of a rock-fill dam. Because of its typically high estimated cost and extended construction time, this facing method has not been frequently used. It has, however, been used at Stacy and Lake Alan Henry Dams.

**5.8.11 RCC with lagging anchored cast-in-place concrete**—A modification of Fig. 5.5(c) and 5.6(c) uses a temporary blockout at the face for every other lift (Fig. 5.5(d) and 5.6(d)). The blockout is removed before placing the conventional facing and the next RCC lift. Added watertightness can be achieved by using a simple swelling-strip waterstop that is impregnated with chemical grout. It is placed along the lift surfaces of the facing concrete. If seepage occurs, the moisture causes the strip to swell and create a watertight pressure seal against the adjacent lift surface.

**5.8.12 RCC with lagging anchored slipformed concrete**—Slipformed concrete with anchors and two-way reinforcement, placed after completion of the RCC, is shown in Fig. 5.6(g) and is suitable as a flow surface.

The aforementioned systems use a variety of measures to control potential seepage through the RCC lifts. Internal measures include mixture proportions that contain an abundance of paste so that bonding along the lift surface is improved. Regardless of what facing design or seepage control measures are selected, good bond is essential at the lift joint and at the interface between the dam and the foundation. External measures include a number of features discussed herein.

- The seepage control measures used for particular facing systems can be used for most of the other facing systems. Drains can be installed between the membrane and RCC;
- The use of bedding mixture between the lifts can substantially improve watertightness and bond along horizontal lift joints. This practice has become the more common approach to reducing seepage at lift joints;
- Added watertightness can be achieved by using a simple swelling strip waterstop that is impregnated

with chemical grout. It is laid along the facing mixture lift surface. If seepage penetrates the lift joint, moisture causes the strip to swell and create a watertight pressure seal against the adjacent lift surfaces; and

- Another approach for RCC dams is to attach the membrane to the face of the dam with external profiles that also serve as a drain system to relieve uplift pressure at the face. The membrane is a special formulation of PVC, usually 0.08 in. (2 mm) thick, that is resistant to exposure and ultraviolet light. It resists puncture and damage from ice and floating debris. Concerns for damage due to vandalism can be overcome with various simple methods to prevent cutting and removal of a sheet of the membrane, but this concern has not been a real problem at the projects in service. When properly designed with appropriate materials and installed by specialists, this proprietary membrane system has essentially provided total watertightness regardless of the cement content, cold joint criteria, construction method, and mixture proportions. Its success has been one of the reasons for using it to stop leakage at cracks that have become a problem from the surface of the dam, if necessary. In addition to watertightness, one of the reasons for using the membrane and face drain system is that it also relieves uplift pressure at the face of the dam, rather than allowing it to enter the body of the dam. Relying on the mass of the RCC itself and watertightness of lift joints requires a reduction of stability due to full uplift at the face, decreasing to some lesser value within the dam depending on internal drainage.

Using a wetter consistency, high cementitious-content mixture (typically with a high percentage of fly ash and a large dosage of retarder), and cooling properly, can result in dramatically better lift joint bond and watertightness compared with more economical mixtures with lower cementitious content, drier consistency, little or no cooling, and no admixture. When done properly, these mixtures generally provide lift joint quality similar to traditional mass concrete lift joints. That is, they are essentially watertight, with occasional instances of seepage. This is not guaranteed though. It is normal to expect some seepage at some lift joints, just as it typically occurs for conventional mass concrete dams.

## 5.9—Spillways, aprons, and stilling basins

Traditional spillway designs used for conventional concrete dams are also appropriate for RCC dams. Gated spillways that include controls, support piers, and spillway chutes, constructed of both reinforced and unreinforced concrete, have been incorporated into RCC structures. Conventional stepped spillways are very common, although smooth spillways are also used. Because erosion resistance of RCC is exceptionally good, unformed spillway surfaces, having the rough textured appearance of the RCC placement, have also been used for low-head spillways or spillways subject to infrequent use (Schrader and Stefanakos 1995). Typically, the rough unformed RCC surface in these spillways

is trimmed back to sound material, with major abrupt irregularities being removed.

For low spillway discharge situations, the spillway and outlet may be combined. The primary spillway and outlet works at Middle Fork Dam were combined in a double-chambered tower placed against the upstream face and connected to conduits in a trench at the maximum section leading to the control structure at the toe (Parent et al. 1985). The conduits were constructed before RCC placement, thus avoiding interference with RCC placing operations.

Spillways with conventional concrete steps have become very common in RCC dams (Campbell and Johnson 1984). They are relatively economical, and because they can be constructed lift by lift with the RCC or as a separate activity trailing RCC placement that is at some higher elevation, they can save time on the overall construction schedule. Steps can also be placed after all RCC is completed, similar to most smooth spillway facings. The steps should be some convenient multiple of the lift height, with two lifts being most common. This is dictated partially by construction forming and convenience, but primarily by hydraulic design. Larger unit discharges require larger steps. Stepped spillways can dissipate substantial energy, thereby significantly reducing stilling basin requirements for low and moderate unit discharges. Steps that are up to several lifts high are not effective for large unit discharges, but larger steps have been modeled and used for these conditions. A notable feature applied to Littlerock Dam in California was a 6 ft (1.8 m) downstream step height used to lessen the likelihood of pedestrians climbing the downstream face (McDonald and Curtis 1997). If steps are kept at a nominal height on the order of 2 to 3 ft (600 to 900 mm), and they are effective for all except extreme floods, the steps will still pass the flood flow. The steps will simply create a boundary layer of low-velocity turbulent flow, with the mass of high-velocity water flowing over this protective layer. The owner should be content to accept the occasion duration and frequency of flow where energy is not effectively dissipated by the steps, such as at Buckhorn Dam.

Stepped spillways have been constructed with almost no reinforcement and with substantial reinforcement, all with good success. Reinforcing does not add to cavitation or erosion resistance. Its purpose is to connect the conventional facing concrete to anchors placed in the RCC mass, and to control the width of drying shrinkage cracks in the conventional concrete. If the facing mixture has minimal shrinkage and contraction joints, reinforcing has been as minimal as just two longitudinal bars tied to the anchors. Contraction joints with no continuous reinforcement should be placed at all monoliths in the RCC mass. Primarily for aesthetic reasons, intermediate contraction joints are normally placed at approximately 6 to 12 ft (2 to 4 m) spacing, typically with half the reinforcement being continuous through the joint. Anchorage for stepped spillways is primarily a judgmental design with a wide range. Typically, two anchors are used for each step height and contraction joint spacing, but there are many variations. The tendency is to have less anchorage

when the facing concrete is placed concurrently with, or very soon after, the RCC.

As with stepped spillways, smooth conventional concrete slabs placed over RCC have had a wide range of judgmental anchoring systems, but always with more concern than for stepped spillways. In addition to uplift pressure from potential leaking lift joints that is trapped by the slab, the slab can also be subjected to negative pressures from high-velocity surface flows. The slab is typically designed with waterstops to prevent velocity head from getting under the slab at construction joints. Reinforcing steel is typically designed by a combination of judgment, structural design for the slab being supported by the anchors, and reinforcement to keep shrinkage cracks small enough to prevent velocity head from penetrating.

The Copperfield Dam has been in service for 20 years with routine small discharges and occasional major floods with high velocities. It has a smooth spillway surface that was constructed by placing low-shrinkage conventional concrete lift by lift with the RCC, and compacting the RCC into the fresh concrete. The spillway has no contraction joints, no reinforcement, and no anchors. It required extreme quality control during construction and the practice has not been readily adopted.

RCC has also been used to construct anchored and reinforced stilling basin slabs and aprons. Willow Creek, Buckhorn, Burton Gorge, and Burnett River Dams are examples. Reinforcement is typically placed only in the top slab, which normally has a higher strength on the order of 3000 to 5000 psi (21 to 35 MPa). The maximum aggregate size is typically 1 to 1-1/2 in. (25.0 to 37.5 mm).

### 5.10—Outlet works

Outlet structures and conduits can provide obstacles to RCC placement. The preferred practice in placement of outlet works in RCC design is to locate the conduits in or along the rock foundation to minimize delays in RCC placement.

Conduits are usually constructed of concrete-encased steel pipe or conventional concrete before initiating RCC placement. Locating the intake structure upstream of the dam and control house and the energy dissipator downstream of the toe also minimizes interference with RCC placement. While used, the avoidance of large embedments in the dam can simplify the construction, minimize schedule impacts, and maximize savings. The conduits are usually installed in trenches beneath the dam or along an abutment. It may sometimes be possible or even necessary to route outlets through diversion tunnels. In situations where conditions dictate that waterways must pass through the dam, the preferred approach is to locate all of the penetrations in one conventionally placed concrete block before starting the RCC placements; this permits proper cooling of the conventional concrete and eliminates interface problems between the RCC and conventional concrete.

Some RCC flood-control projects have combined one conduit to serve the purpose of a passageway or roadway through the dam for normal conditions, and to act as an



ungated outlet during floods (Schrader 2002; Schrader and Balli 2003).

## CHAPTER 6—CONSTRUCTION OF ROLLER-COMPACTED CONCRETE DAMS

### 6.1—General

The layout, planning, and logistics for construction with RCC are somewhat different than for conventional mass concrete construction. Instead of vertical construction with independent monolith blocks, RCC construction involves placing relatively thin lifts over a large area. Conventional mass concrete placement usually requires a high ratio of labor hours to volume placed due to labor-intensive activities, such as forming faces, joint preparation, and consolidating concrete with internal vibrators. RCC typically has a lower ratio of labor hours to volume placed because of the use of mechanical equipment for spreading and compacting the mixture, less forming, and reduced joint cleanup. More labor and attention is required to provide wet curing for RCC because membrane-forming curing compounds are prohibited due to their adverse effects on lift joints.

Recent trends in RCC construction have centered on developing equipment and methods for placing multiple lifts of RCC quickly, before the concrete has reached its initial set. This improves the bonding between successive lifts and decreases the cost of cleaning lift surfaces and placing costly bonding mortar. Intensive lift surface preparation can decrease the RCC placing rate by up to 50%. The trend to rapid lift placing has been fueled by the construction of much larger RCC dams in the last decade and more accepted use of retarding admixtures to delay the setting time of the concrete until after the next lift is placed. Rapid placing rates should also be accompanied by new methods of constructing the upstream and downstream faces of the dams and handling and cooling the concrete. The sloping layer method of placing RCC and the development of GERCC facing are two construction innovations that have markedly increased the ability to rapidly place successive lifts of RCC without affecting the forming progress.

With the rapid construction progress typical of RCC placement, when problems develop in the placing area, they should be resolved quickly. There usually are no alternate monolith blocks in RCC construction where work can progress while a problem is resolved. Raising a portion of the placing area ahead of the problem area has been done, but it can later result in placing difficulties and potential planes of weakness. Planning and preparation of materials, access, embedded parts, and foundation and lift cleanup before the start of RCC placement are essential. It is also essential that lines of communication between the engineer and contractor be well-established so that they can quickly resolve problems and specification compliance issues that may impact the progress of the work. Interruptions and slowdowns generally cause reduced joint and RCC quality, as well as increased costs.

Impediments to placement and compaction rates can reduce the RCC quality. Equipment, fueling, formwork, and assembly of embedded items should all be scheduled and planned so that the majority of this work is accomplished off

the RCC surfaces and during shift changes or scheduled downtime. All unnecessary vehicles and personnel should be kept out of placing areas and equipment paths.

The inter-relationship between design assumptions and construction methods has a significant effect on the success of the project. Successful construction of RCC dams is achieved by selecting equipment and plant systems with production rates to match the design assumptions and specifications requirements. This includes selecting an RCC production and placement rate and forming system for the upstream and downstream faces of the dam and matches the anticipated rate of rise of the dam to meet lift surface bond strength requirements. A common problem occurs when inevitable production breakdowns or slowdowns invoke stringent specifications requirements for lift surface treatment, which reduces the placement rate. The reduced placement rate for lift surface treatment can again cascade and invoke the same lift surface treatment requirements, causing further delays in production. Arguably, the most successful RCC projects have been built with production and delivery systems that very rarely are the controlling production features. An example is Stagecoach Dam, where the 150 ft (46 m) dam was placed in 35 production days, averaging better than four lifts per day, including gallery construction, drain-hole drilling, cast-in-place facings, and an intentional spillway break (Arnold and Johnson 1992). Above the gallery and below the spillway break, 60 lifts were placed in 10 days, production being limited by face forming procedures (the plant and delivery capacity was never the controlling factor). Achievable plant capacity was in excess of 250 yd<sup>3</sup> (190 m<sup>3</sup>) per hour, yet the overall project average per shift hour was less than 100 yd<sup>3</sup> (76 m<sup>3</sup>) per hour. While this was not often challenged, the RCC was available whenever needed.

### 6.2—Aggregate production and batching and mixing plant location

Aggregate stockpiles and the concrete plant location for RCC can be even more important than for conventional concrete. Typically, large stockpiles are provided before starting RCC placement. Reasons for this include:

1. *Temperature control: producing aggregates during the winter (or summer) so that they are stockpiled cold (or warm) for later use*—When the aggregates are produced during cool (or warm) weather, there is a temperature lag between the concrete placing temperature and the ambient temperature. Rapid RCC placement following aggregate stockpiling can result in concrete temperatures several degrees lower (or higher) than ambient temperatures. At Middle Fork and Stagecoach Dams in Colorado, Grindstone Canyon Dam in New Mexico, and Monksville Dam in New Jersey, winter stockpiling resulted in aggregates with occasional frozen zones in the stockpiles, remaining as late as late May. At Burton Gorge Dam in Australia, instrumentation showed that production of RCC aggregate at night resulted in a 9°F (5°C) lower aggregate stockpile temperature than similar aggregates produced during the day.

2. *Rapid placement rate*—The rate of aggregate use during RCC placing may exceed the capacity of an aggregate production plant.

3. *Aggregate stockpile moisture*—Large aggregate stockpiles also have the benefit of more stable moisture contents, which reduces variations in RCC consistency.

The location and configuration of stockpiles, as well as the means of aggregate and withdrawal from stockpiles, must be coordinated with the RCC plant location and method of feed to minimize segregation and variability. At the very high production rates possible with RCC, several loaders or a conveyor system may be required to keep the aggregate feed bins charged. The length of haul and size of turnarounds need to be considered so that transportation equipment can operate rapidly, efficiently, and safely. If a rewashing/rescreening plant is required at the batching plant, the plant rate is frequently reduced by the aggregate feed and screen rate and may be further reduced if the screens become overloaded or the aggregate gradation is highly variable.

Inadequate cementitious material delivery and storage has limited RCC production on some projects. A steady flow of these materials is necessary for optimum production and consistent RCC quality.

The RCC plant layout and location should be selected to minimize energy requirements and be appropriate for the terrain, whether the RCC is transported by conveyor or by haul vehicles. The location should minimize overall haul distances, vertical lift, and exposure of the fresh mixture to sun and inclement weather. The plant should be located on a raised area and graded so that spillage and wash water drain away without creating a muddy area, especially if vehicular haul is used. The plant location for dams will generally be in the future reservoir area and above the cofferdam level, or on one of the abutments. A plant location adjacent to the RCC structure minimizes transport time, which is critical to RCC quality, and reduces transport equipment needs. The plant should have a bypass or belt discharge that allows for wasting out-of-specification RCC without delivering it to the dam.

### 6.3—Batching and mixing

6.3.1 *General*—The RCC method changes the production-controlling elements of mass concrete placements, from the rate of placement for conventional mass concrete to the output of the concrete plant and delivery system for RCC. Recent trends include the development of batching and mixing plants specifically for RCC construction rather than modified conventional plants. This includes more sophisticated controls for both continuous volumetric and continuous weighing plants with the ability to batch admixtures and use of twin-shaft compulsory mixers. Batching can be achieved by conventional weigh-batching, continuous weigh-batching using belt scales, and continuous volumetric batching with either vane feeders or cleated belt feeders. Mixing has been accomplished by conventional drum mixers, continuous pugmills, or batched twin-shaft compulsory mixers.

Rapid and continuous delivery of RCC is important to mass applications. The theoretical, or rated, peak capacity of the plant is invariably well above the desired average

production. As a general guide, the average sustained placing rate does not usually exceed approximately 65% of the peak or rated plant capacity when haul vehicles are used for delivery on the dam, and 75% when conveyor and hauling vehicles or an all-conveyor delivery system is used. These values tend to be lower on smaller projects and higher on uncomplicated or larger projects.

RCC mixers should accomplish two basic functions: to thoroughly blend all ingredients and to provide sufficient capacity for high placing rates typical in RCC. Typical placing rates are 100 yd<sup>3</sup>/h (76 m<sup>3</sup>/h) for small projects, 250 to 500 yd<sup>3</sup>/h (190 to 380 m<sup>3</sup>/h) for medium projects, and 750 to over 1000 yd<sup>3</sup>/h (570 to over 760 m<sup>3</sup>/h) for large projects. Several individual mixers are used to provide the higher production rates. Scheduled maintenance should not be neglected, and repairs should be accomplished rapidly to minimize downtime.

Batching controls should be calibrated for the lower quantities of cementitious materials common with RCC. For example, a typical 2% tolerance for a 10 yd<sup>3</sup> (7.5 m<sup>3</sup>) batch of conventional concrete is 120 lb (55 kg), whereas for a typical RCC batch, the same 2% tolerance may be only 25 lb (11 kg) each for cement and pozzolan, and may be beyond the scale tolerances of some concrete batching plants.

Variations in free moisture content of the aggregates can be particularly troublesome at plant startup. Providing too little water in the initial mixtures is particularly undesirable because initial mixtures are frequently used for covering construction joints or foundation areas where the RCC should be on the wet side for improved workability and bond. It is better to start with higher moisture content and to subsequently reduce it to the desired consistency than to start with a mixture that is too dry. RCC placed with a higher-than-optimum moisture content is typically more dense and has lower air voids and permeability. Care must be taken to avoid an overly wet mixture, which reduces the RCC strength. Variability in moisture content significantly affects the quality of the RCC.

Accurately introducing the specified quantities of materials into a mixer is only one part of the mixing process. Uniformly distributing and thoroughly blending materials, and discharging them in a continuous and uniform manner are also essential for providing quality RCC. Distributing and blending can be more troublesome with some RCC mixtures than with conventional concrete mixtures because of the lower unit water content in the RCC mixtures.

Both continuous mixers and batch mixers have been used to produce RCC. Continuous mixers generally provide higher output capacity than batch-type plants. Continuous pugmill mixing plants that are specifically intended for RCC and are properly operated and maintained, routinely achieve the high production rates and uniformity required for mass placements. This applies to plants that operate with volumetric controls, as well as those that operate on weight controls. Operation of drum mixers requires less power than pugmill mixers. Batch operations with drum mixers tend to cause the most difficulties or concerns in producing RCC, as discussed

in Section 6.3.2. Traditional batch plants may be needed for batching conventional concrete associated with the project.

**6.3.2 Batching and drum mixing methods**—RCC has been successfully produced with conventional batch type plants and drum mixers. Lower production, bulking, sensitivity to the charging sequence, slow discharge, and buildup in the mixer are common problems in RCC production compared with batching of conventional plant and transit-mixed concrete. Equipment that is well-suited to normal high-production conventional concrete is not necessarily suitable for all RCC mixtures and the typically higher production rates required. Proper ribboning or sequencing and feed rates of the aggregates and cementitious materials as they are fed into the mixer are important factors in minimizing mixing time and buildup for both drum-type batch operations and continuous mixers. The timing of adding water to the mixture and the angle of its introduction have been critical in drum mixers. Each plant and RCC mixture has unique requirements that can only be determined by trial and error and experience with RCC.

While RCC mixtures vary in paste and fines content and plasticity, mortar buildup in mixers is common. Drums are particularly susceptible and should be designed or coated to resist buildup that tends to result from the high fines content of some RCC mixtures. Even with these precautions, substantial buildup can develop on the vanes in drum mixers. If the buildup is not removed daily, it results in a loss of mixer effectiveness, both lessening quality and production capacity.

For small jobs, the conventional batching/mixing plants may also be used for other conventional concrete placements, particularly if the conventional concrete and RCC are not placed concurrently. This is not desirable for larger jobs due to the delays in RCC production. Inherent problems with this approach include aggregate feed complications, concurrent demand, and increased mixer maintenance.

Transit mixer trucks and mobile batch plants should be avoided, except for small-volume applications with relatively high cementitious-content mixtures, and mixtures with NMSA limited to approximately 1 in. (25 mm). Even with these types of mixtures, slow discharge or a need for discharge assistance should be anticipated.

**6.3.3 Continuous batching and mixing methods**—Two types of continuous batching systems are presently being used for RCC: a weigh-recording/batching system that records product feed using belt scales, and a volumetric-batching system that records product feed via calibrated proportioning devices. Both systems perform well when the plant feed rate is held constant and the moisture content of aggregates are consistent. The continuous weigh-batching plant used at North Fork of Hughes Dam in West Virginia was equipped with sensors to automatically compensate for moisture variations and could also continuously batch admixtures. Continuous batching plants require accurate calibration before operation and continuous monitoring to ensure product feed. Volumetric proportioning plants typically record input revolutions of proportioning devices, regardless if product is actually being fed at the calibrated rate. Some continuous volumetric plants record output feed weight via a

belt scale as a product check. Volumetric proportioning of sand is sensitive to bulking in the normal moisture contents obtained in stockpiles, and may thus affect the yield quantities.

Accurate and consistent control of cement and pozzolan feed is particularly important with continuous mixing plants. This is especially true at lower cementitious materials feed rates. Maintaining sufficient head in the silos using air fluffers, vane feeders, or positive-displacement cleated belt feeders has provided accurate feed of cementitious materials. At Cold Springs Dam spillway, the cement silo was mounted on load cells to provide an additional check of the continuous weight-recording system. Continuous batching and mixing plants should be checked for yield at regular intervals to ensure accurate product feed. This requires regular density tests to determine product quantities. Typically, the yield is determined for each production shift. For smaller jobs, it is convenient to obtain the yield quantities when new truck-loads of cement arrive on site.

Properly designed pugmills have mixed 3 in. (75 mm) and larger NMSA mixtures, but the amount of material larger than 2 in. (50 mm) should not exceed approximately 10%, and the maximum size should not exceed 4 in. (100 mm). Continuous drum mixers have been used successfully with 6 in. (150 mm) NMSA. Daily cleanup of buildup is also necessary for the mixing boxes of pugmill-type mixers.

**6.3.4 Mixer uniformity**—Mixture uniformity should be checked and maintained at all production rates that will be used. Continuous mixers typically work efficiently above a minimum production rate, and up to production levels that are two to three times that of the minimum rate. Variations in production requirements, such as near abutments around galleries or other confined areas, can be accommodated on large projects with multiple mixers by shutting down some of the mixers until the higher production rate is needed again. On smaller projects with one mixer, the mixer itself should be capable of uniform production at varying outputs. Mixture variability with regard to design, equipment, and experience is discussed in more detail in Schrader (1987a; Schrader and Namikas 1988).

The accuracy of the concrete plant and methods for control of the mixture during production should be studied for cost effectiveness and mixture strength requirements. If exacting quality control and low variability are necessary, they can be provided in RCC mixtures, but at increased cost and possibly reduced placing rates. Typical coefficients of variation for RCC compression tests with reasonable weight or volume controls in mass mixtures tend to be approximately 10 to 20%, with extremes ranging from approximately 5 to 45%.

## 6.4—Transporting and placing

The process of mixing, transporting, placing, spreading, and compacting should be accomplished as rapidly as possible and with as little rehandling as possible. The time lapse between the start of mixing and completion of compaction should be considerably less than the initial set time of the mixture under the conditions in which it is used. A general rule for mixtures with little or no pozzolan is that placing (depositing), spreading, and compacting should be accom-



Fig. 6.1—Transporting RCC by conveyor discharging to waiting end dump trucks on lift surface, Al Wehda Dam, Hashemite Kingdom of Jordan. (Photo courtesy of Edward Warren, Water Power and Dam Construction, 2009.)

plished within 45 minutes of mixing, and preferably within 30 minutes of mixing. This limit is applicable at mixture and weather conditions of approximately 70°F (21°C) and with mixtures that are not set-retarded. The time can be extended for cooler weather, and should be reduced in warmer weather. Low humidity, windy conditions, and multiple handlings can decrease workability and reduce the allowable time for completing compaction to less than 45 minutes.

**6.4.1 Equipment selection guides**—The volume of material to be placed, access to the placement area, availability of rental or lease equipment, capital cost for new equipment, and design parameters are generally controlling factors in the selection of equipment and procedures to be used for transporting RCC from the mixing location to the placing area. RCC is usually transported by vehicles, conveyors, or a combination of both. The transport system is selected based partly on the mixing system used. When a partial conveyor system is used, it typically involves transport by conveyor to a hopper on the dam or directly into trucks for final delivery to the spreading area (Fig. 6.1). The use of holding hoppers designed to control segregation enables continuous mixers to be used with vehicle transportation and batch mixers to be used with conveyors. Equipment and procedures currently available are capable of mixing, delivering, and placing RCC at sustained rates in excess of 1000 yd<sup>3</sup>/h (750 m<sup>3</sup>/h). It is important to realize that productions of this magnitude are only achieved through custom-designed batching and delivery systems.

**6.4.2 Segregation considerations**—The maximum size of the aggregate and the tendency for the mixture to segregate are major factors in selecting equipment used to transport RCC from the mixing plant to the placement area. A 1-1/2 in. (37.5 mm) NMSA concrete can be transported and placed in nonagitating haul units designed for aggregate hauling and earthmoving, without objectionable segregation. Conveyor systems should be designed to minimize segregation at transfer points. RCC mixtures with a 3 in. (75 mm) NMSA have a greater tendency to segregate when they are dumped onto hard surfaces, but with care and proper procedures,

these mixtures have been hauled, dumped, and remixed successfully. Severe segregation can occur during the transportation and placing of large NMSA and drier-consistency mixtures. Design of wetter-consistency mixtures also reduces the tendency of mixtures to segregate. Hand labor is often required to remove or remix segregated material before compaction, and the amount of hand labor will depend on the degree of segregation and design requirements.

**6.4.3 Transporting methods**—The two principal methods of transporting RCC are by conveyor, hauling vehicles, or a combination of both. Transport by bucket or dinky have been used, but these slow the rate of production, and are more prone to cause segregation. If such a system is already available (or necessary) for large volumes of conventional concrete, it can also be used for the RCC.

**6.4.3.1 Conveyors**—Transport by continuous high-speed conveyors from the concrete plant directly to the placement surface in particular for dams is ideal. The overall economics, including direct and indirect costs of alternate delivery systems, as well as reliability, final quality, and schedule, should be considered when deciding whether to use or require a conveyor delivery system. All aspects of the conveyor system should be specifically designed for RCC of the type used on the project. Conveyor systems that work well with a conventional concrete may not work well with a low cementitious, drier, larger-aggregate, or high-fines RCC. Some areas that need particular attention in the design and operation of conveyors are as follows: clogged transfers, segregation at the point of discharge, severe wear at transfers, segregation over rollers, slow belts, not being able to start or stop a loaded belt, drying, loss of paste, and contamination of the RCC lift surface from material dropping off the return side of belts. It is especially important that conveyors do not allow RCC or other material to ravel and scatter onto the compacted RCC surface along the conveyor path. This can cause a contamination area that will require extra cleaning between lifts. Because of the rapid rise of RCC dams, conveyor systems should be designed to be raised quickly. When conveyors are located above the lift surface, provisions should be made for the spreading and compacting equipment operating beneath the delivery system.

As with conventional mass concrete conveyor systems, special attention should be given to belt widths, speed, protection, maintenance, incline angles, backup systems, and spare parts. Belt scrapers should be provided to clean the return belt. These typically require frequent attention for adjustment, maintenance, and wear. Properly designed charging and discharge hoppers to prevent segregation at transfer points are essential. Exposure time on conveyors should be as short as practical, with 5 minutes being desirable and 10 minutes being a normal limit. Belt speeds should be approximately 10 to 30 ft/s (3 to 9 m/s). Covering the conveyor to protect the mixture from drying and from rain should be considered for all long sections and, preferably, for the entire system.

A well-designed conveyor system can also be capable of handling conventional concretes that may be used concurrently with the RCC. This may require modifications such as

differing wiper designs, and may complicate the placing operation unless separate parallel conveyors for the RCC and conventional concrete are provided.

The use of a conveyor system with a belt feeding continuously from a pugmill mixer to a hopper on the dam is shown in Fig. 6.2. To date, the highest placement rates for RCC dam construction, averaging over 12,000 yd<sup>3</sup> (9000 m<sup>3</sup>) per day, have been achieved with combined systems of conveyors discharging the RCC directly to waiting hauling trucks which then transports it to the placement area (Dunstan et al. 2003). At Olivenhain Dam (Fig. 6.3), peak rates up to 16,000 yd<sup>3</sup> (12,000 m<sup>3</sup>) were achieved with the



Fig. 6.2—Partial conveyor system to hopper on dam.

conveyor-hauling truck system (Reed et al. 2003). Conveyor systems from a mixing plant to the placement area provide rapid transport and allow more time for spreading and compaction. Some problems with conveyor systems include continual raising of the hopper, if used; segregation at the edges of loads dumped into and out of trucks; damage to the surface caused by the hauling equipment; and insufficient room at the top of the dam for equipment. Conveyor systems reduce the need for multiple access roads that need to be raised with the dam and reduce lift contamination and cleaning problems that occur with truck hauling equipment. Trucks are preferred for hauling RCC. Front-end loaders have been used for smaller jobs and in confined spaces.

All-conveyor delivery systems are shown in Fig. 6.4 to 6.6. The first system, shown in Fig. 6.4, uses embedded steel columns raised with the dam to support and raise the conveyors. Swinger conveyors reach from the columns to essentially the entire dam surface. The second (Fig. 6.5) uses segmented conveyors to feed a crawler-mounted conveyor traveling on the dam and reaching out to all placement areas. A detailed discussion of -conveyor equipment and methods can be found in Schrader (1994). Figure 6.4 shows conveyor delivery of conventional concrete on a separate belt parallel to the wider RCC belt. At Miel I Dam (Fig. 6.6), an all-conveyor placing system achieved an average placing rate of 5500 yd<sup>3</sup> (4200 m<sup>3</sup>) per day, with a peak rate of 9400 yd<sup>3</sup> (7200 m<sup>3</sup>) per day (Marulanda et al. 2003).

A continuous belt conveying from the mixer to the final placement area can reduce other equipment needs with their related labor requirements. Regardless of the delivery



Fig. 6.3—Overview of RCC placement operations using conveyors transporting RCC from the batching/mixing plant to the dam body and transferred to end dump trucks, Olivenhain Dam, CA. (Photo courtesy of San Diego County Water Authority, 2002.)

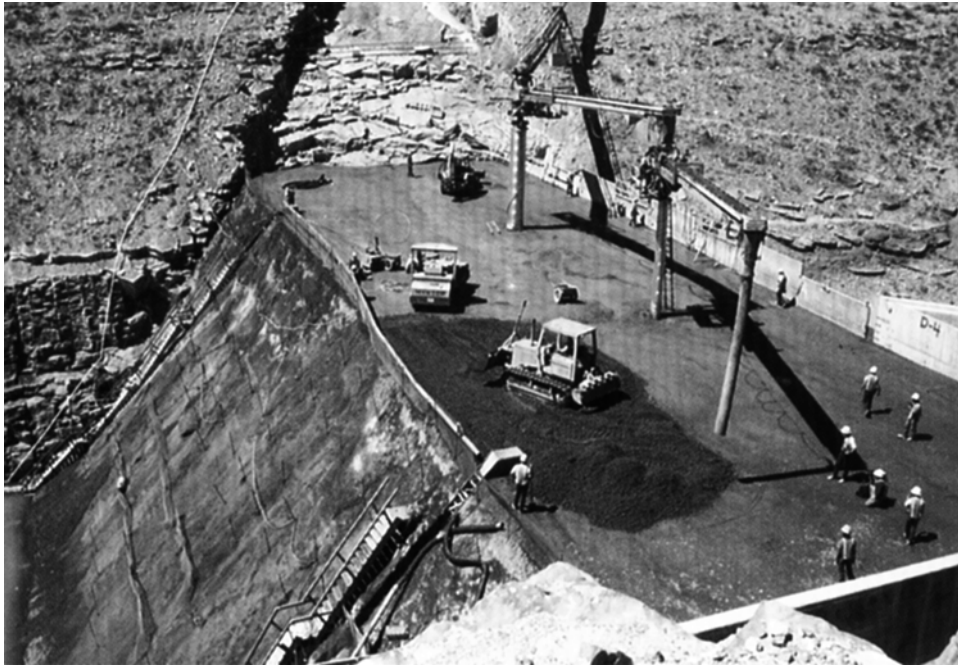

Fig. 6.4—All-conveyor RCC placing with embedded steel columns and “swinger” conveyor.



Fig. 6.5—RCC placed on dam body with crawler-mounted conveyor on dam surface, Saluda Replacement Dam, SC. (Photo courtesy of Barnard Construction, 2004.)

system, the productivity achievable in wide and unobstructed lifts is commonly much higher than when obstructed or when lifts tend to get longer and narrower nearer the dam’s crest. Conveyor systems should be properly maintained, and the contractor should have prompt repair capabilities for both the mechanical and electrical systems. As with many plant or delivery system breakdowns, if the conveyor system breaks down, RCC construction stops unless an alternative transport method has been planned.

**6.4.3.2 Haul vehicles**—If vehicles are to be used for transporting RCC from the batch plant to the dam, a thorough study should be made of the haul road system. Problems that may prevent hauling by road include steep and rough terrain, lack of road-building material, ever-changing access elevations, crossing face forming systems, plant location, schedule, and precipitation. If the concrete plant is located

upstream of a dam, the method of bringing the road through or over the upstream face system should be worked out in detail. From a scheduling standpoint, construction of roads should be completed before the start of RCC placement. Raising the roads fast enough to keep up with the rate of rise of the dam may require so much time that it becomes an inefficient system at higher elevations. To avoid slowing the mixing and placing operations, raising the haul roads during a 2- to 4-hour-per-day shutdown period while maintenance and other work is being performed should be considered. The roads should be kept at slopes consistent with the equipment capabilities and safety requirements.

Haul roads should transition onto the lift surface at a shallow angle if possible so that turning and damage of RCC by tires is minimized. If an immediate right-angle turn is needed (from roads that enter directly onto the dam perpendicular to the face), significant scuffing and lift surface damage can result. The vehicles should move slowly while turning and use the largest turning radius possible or have an exit point that avoids turning. The haul road surface should be constructed with clean, free-draining rock or gravels if possible.

The last portion of the road before entering the lift should be surfaced with clean large aggregate or rock material that minimizes contamination of the RCC surface from truck tires. To prevent lift contamination, it may be necessary to use water sprays to wash vehicle wheels before they are allowed on the lift surface. Watch for excess water dripping from the truck and its tires, which can become a problem. To minimize adverse effects on the surface, hauling equipment should not travel in a concentrated path on the lift. Even with all of the aforementioned precautions, damaged lift surfaces should be expected where haul roads are used for vehicles traveling onto the dam, particularly during inclement weather.

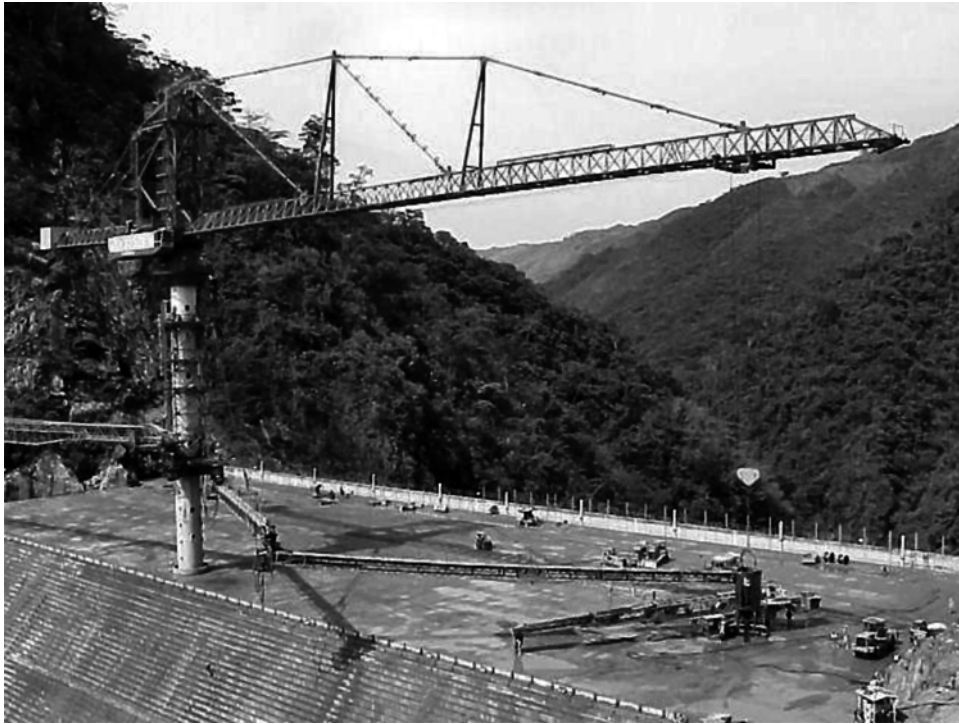

Fig. 6.6—All-conveyor RCC placing system for Miel I Dam, Colombia. (Photo courtesy of INGETEC S.A., 2002.)

When haul units are used to distribute RCC that is conveyed to the lift surface, a system for loading onto the vehicles is needed at the end of the main conveyor (Fig. 6.7). The objective is to allow the mixers and conveyors to operate and discharge without interruption or waiting for the haul vehicles. Gob hoppers may be used, or the conveyor should be configured to switch to adjacent, waiting trucks without spillage. A recommended minimum size of the hopper is twice the size of the haul vehicle. Because of the relatively high unit weight of freshly mixed RCC compared with the loose unit weight of soil, rock, or gravel normally hauled in these vehicles, weight rather than volume normally controls the amount of material hauled per trip.

Bottom-dump trailers and scrapers minimize spreading requirements and the distance RCC drops, but they are difficult to use in small placements near abutments in dams and other obstructions. Scrapers have better mobility than bottom dump trailers, but tend to tear the surface when making sharp turns. Scrapers and bottom dump trailers have the advantage of depositing material in the layer to be spread as they are moving.

Front-end loaders have been used to deliver RCC from a central feed point on the placement surface to the location where it is spread. This method has production limitations not suitable for large projects, and can have problems with segregation and lift surface damage from repeated turning, particularly with lugged tires. Front-end loaders can be economically and technically beneficial where the mixture is not susceptible to segregation, where spillage can be avoided, and where tire tracking is not a problem, such as if the next lift is placed before the initial setting of the previous lift. Principal candidates for this approach are smaller dams



Fig. 6.7—Discharge conveyor that allows uninterrupted loading of RCC into adjacent trucks, Upper Stillwater Dam, UT. (Photo courtesy of U.S Bureau of Reclamation, 1986.)

in tight canyons where the distance for loader travel is minimal, and the batch size or RCC is the same as the loader bucket. In addition, the projects should have a smaller maximum-size, well-graded aggregate with a tendency for a higher paste and cementitious content. Extra cleaning or special grout or bedding mixtures may be appropriate between lifts when they are not placed and compacted before the time the previous lift reaches its final set.

When the RCC is hauled to the placement location and dumped, it should generally be deposited on previously spread but uncompacted material (Fig. 6.8) and pushed



Fig. 6.8—Dumping fresh RCC onto previously placed and spread, uncompact lift, Deimer Dam Modification. (Photo courtesy of MWH Global, 2007.)

forward on to the compacted lift surface. This provides remixing action and minimizes clusters of coarse aggregate that otherwise would tend to occur at the lift interface. When RCC is dumped in large piles, larger aggregates tend to roll down the outside of the piles and create clusters. A general rule is to limit the height of a pile to 5 ft (1.5 m) or less. Correcting this kind of segregation is nearly impossible if the rock has already rolled onto a previously compacted lift. Where this condition occurs, the segregated large aggregate should be removed and wasted or broadcast onto the RCC layer being spread. As with conventional concrete, RCC should not be dropped free-fall without chutes or trunks more than 4 ft (1.3 m).

**6.4.4 Placing and spreading**—Placing and spreading methods have undergone a transformation during the past decade of RCC construction. Early dams placed the RCC in horizontal or nearly horizontal lifts. The RCC was placed in either a 1 ft (300 mm) compacted lift or in multiple layers of uncompact RCC stacked to form a compacted lift up to 3 ft (900 mm) thick. Beginning in the mid-1990s, the sloping layer method of placement was introduced at Jianguya Dam in China (Forbes et al. 1999). This technique has rapidly grown in popularity, and will be discussed separately in this chapter.

The preferred technique of placing RCC in a dam is to advance each lift from one abutment to the other. An exception is where the distance from abutment to abutment is shorter than the distance from the upstream to the downstream face, such as at the bottom of dams in narrow canyons. In this case, placement can be started by working in the upstream-downstream direction. Unless it is carefully controlled, placement in the upstream-downstream direction may result in segregation along lateral placement edges that cause porous zones through the structure. This can be particularly critical for RCC mixtures with a tendency to segregate. Although the sloping layer method does not alter this concept, the higher lift thickness changes the typical operations related to placing and spreading methods.

Some projects have required placing RCC in paving lanes, typically going from abutment to abutment. The problems with placing RCC in paving lanes are more serious with lower cementitious-content, dryer-consistency, and larger-aggregate mixtures. Spreader boxes attached to dump trucks, spreaders attached to dozer equipment, and paving machines lack mobility and occupy space in narrow areas of the dam. They can be difficult to maneuver at the abutments. Paving lanes can leave segregation along the edge of the lanes with dam mixtures. The edges can also become too old to be compacted into RCC of the adjacent lane by the time the adjacent lane is placed. The edge also tends to dry out while exposed before placing the adjacent lane. This has resulted in concerns over poor quality and weakened or permeable planes in the dam at the interface of paving lanes. This practice should be discouraged unless the problems described can be satisfactorily addressed. Motor graders have been used on some RCC projects for spreading RCC. They are difficult to maneuver in small areas and at abutments. The tires and blade can damage compacted surfaces. There is also a tendency to overwork and rework the surface.

Tracked dozer equipment has proven to be best for spreading RCC. Tracked dozers are fast, sufficiently accurate, and contribute to uniformly compacted RCC. By careful spreading, a dozer can remix RCC and minimize segregation that occurs from dumping. Careful attention should be given to ensure that remixing is occurring and that the dozer is not simply burying segregated material. Dozers using U-shaped blades are typically modified by welding extension plates on the edges of the blades to limit segregation that can occur as RCC rolls off of the edge during spreading. Dozers should have at least hydraulic tilt capability and preferably both tilt and angle hydraulic capability. The dependability of the equipment and quality of the operator have a significant effect on controlling segregation and spreading a uniform lift thickness.

A dozer typically spreads the RCC in a  $12 \pm 2$  in. ( $300 \pm 50$  mm) thick, loose lift in a manner that allows the dozer to operate on uncompact material. Dozers with street grouser rubber tracks, or worn tracks, are preferred so as to minimize breakdown of the aggregate, shearing of the RCC, or both. Laser surveying equipment is used on many projects for controlling the grade of grading lift surfaces.

At Elk Creek Dam, RCC mixtures with a set-retarding admixture and a Vebe time of 15 to 25 seconds were end dumped in piles on previously spread but not-yet-rolled material at least 40 ft (12 m) from the advancing face (Hopman and Chambers 1988). Mortar was spread on each hardened lift surface to a thickness of approximately 1 in. (25 mm), similar to the Japanese RCD method. Dozers leveled the piles and spread the RCC forward into 6 in. (150 mm) thick layers until a full lift thickness of 24 in. (600 mm) was reached. Two double-drum 11 ton (10 metric ton) vibratory rollers and three 25 to 80 ton (23 to 72 metric ton) dozers were able to spread and compact the 24 in. (600 mm) lift thicknesses at a rate of more than 900 yd<sup>3</sup>/h (690 m<sup>3</sup>/h). The entire surface of each 6 in. (150 mm) layer was traversed by at least two passes of the dozer tracks. This



dozer action produced an average density of 146 lb/ft<sup>3</sup> (2350 kg/m<sup>3</sup>), or approximately 98% of the optimum compaction density. Additional compaction of the roller was added only to the 24 in. (600 mm) full thickness of the lift. If the mixture had not contained a retarder, more equipment or thinner lifts would have been needed. Typically, two rollers and one 18 ton (16 metric ton) dozer, with a backup dozer, can spread and roll RCC at a rate of approximately 300 to 500 yd<sup>3</sup>/h (230 to 380 m<sup>3</sup>/h) in 12 in. (300 mm) thick lifts.

Similar results have been achieved with other RCC mixtures having a relatively plastic mixture consistency. At the Nickajack Dam auxiliary spillway project, wet-consistency, air-entrained RCC was spread in two 12 in. (300 mm) thick lifts, with the second layer following as a step behind the first layer (Cannon 1993). The first layer was substantially compacted before placement of the second layer, and the second layer was compacted before the first reached initial set. The advancing layer was approximately 100 ft (30 m) in front of the following layer.

At Upper Stillwater Dam, end dump trucks were equipped with a tailgate-spreader box, shown in Fig. 6.9, that dumped and spread the RCC in approximately 16 in. (400 mm) thick loose lifts. Only a small dozer was needed for final spreading with placement rates up to 800 yd<sup>3</sup>/h (600 m<sup>3</sup>/h) (Dolen et al. 1988).

Dozers should operate on fresh RCC that has not been compacted. All turning and crabbing should be performed on uncompacted material. Operating the dozer on a compacted surface will damage the RCC. When it is necessary for the dozer to drive onto compacted RCC, the operator should limit the movement to straight back and forth travel, travel on rubber mats, or both, such as on lengths of old conveyor belts. Track marks made before the mixture reaches initial set can be recompacted by the vibratory roller without significant loss of joint quality. Damaged surfaces that are recompacted after the mixture has set or dried can develop compaction planes with little or no strength, even when the RCC has an acceptable surface appearance. Where compaction planes result, the layers will not bond together. This material can be easily removed by blowing with an air jet, even many hours later.

Spreading equipment should leave a flat or plane surface of the proper thickness before the roller compacts the lift. Depending on the workability of the mixture, ridges or steps between adjacent passes of the dozer blade can result in uneven compactive effort and variable quality in the RCC. As a general rule, having a flat surface ready to roll in the least amount of time is more important than having an exact grade with delayed rolling.

Where conventional concrete mixtures are specified for limited areas, for example, at the upstream or downstream face, special procedures are required. If conventional concrete is used against a formed face with a dry consistency RCC mass behind it (Fig. 5.5(c) and (d)), the conventional mixture should be placed first with the RCC immediately spread against and on top of the sloping unformed face of the conventional concrete. The conventional mixture should be proportioned to lose slump rapidly, but not set rapidly. This



Fig. 6.9—RCC dumped and spread with controlled tailgate in 16 in. (400 mm) loose layers prior to compaction. (Photo courtesy of U.S Bureau of Reclamation, 1986.)

allows the RCC to be compacted into the conventional concrete before either mixture sets. If the conventional concrete does not lose slump soon enough, the roller will sink into it with a variety of ensuing construction problems. If rolling is delayed while waiting for the conventional mixture to stiffen, the RCC can become too old for proper compaction. If the roller operator simply stays back from the conventional concrete far enough to avoid sinking into it or shoving it up, the two mixtures may not adequately compact or bond together. Conventional concrete is usually needed for appearance and durability of the exposed face. The minimum amount that can be stacked against the form, approximately 2 to 6 in. (50 to 150 mm) wide, will provide a conventional concrete appearance. Large compactors, however, cannot be operated that close to the forms. The use of smaller compactors may result in lower-density RCC in this area, require placement of thinner lifts, or both. If the conventional concrete zone is wider than approximately 6 in. (150 mm), the conventional concrete is usually consolidated with immersion-type vibrators while the adjacent RCC is rolled.

If the RCC has a wetter consistency, and especially if it has a delayed set, it is possible to place the conventional concrete mixture after the RCC. The facing concrete still needs to have a relatively low slump when RCC compaction is performed, but it can still be possible to immersion-vibrate the interface region of the RCC and conventional concrete. Experience, coring, and internal destructive investigations have shown that a poor interface between conventional concrete and RCC often results in both sequences of conventional and RCC interface placement. Efforts are ongoing to improve the conventional concrete-RCC interface area. The use of GERCC involves pouring grout under or over the uncompacted RCC adjacent to the face of the dam, followed by immersion vibration and roller compaction. This placing method is discussed separately in this chapter.

The most common compacted lift thickness has been 12 in. (300 mm). The trend is to use the thickest lifts compatible with the RCC mixture and the spreading and compaction equipment to achieve the specified minimum density. In

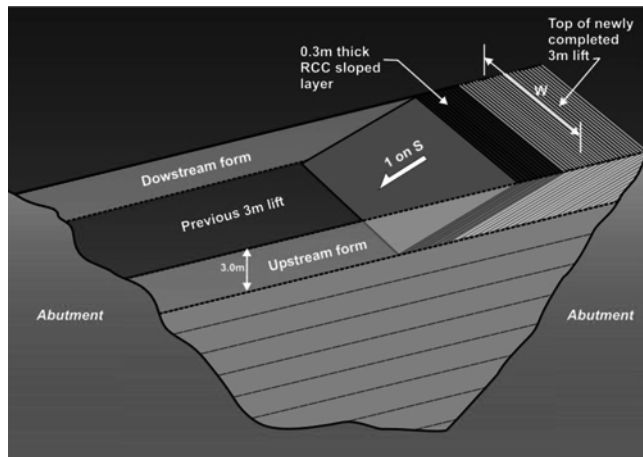

Fig. 6.10—Sloped layer placing method (SLM) (Forbes 1999).

Japan, thicker lifts from approximately 1.5 to 3 ft (0.5 to 1.0 m) have been compacted in one lift after being spread by dozers in several layers. A 12 in. (300 mm) thickness is convenient to work with in the field.

Another factor influencing lift thickness is the maximum allowed exposure time before covering one lift with the subsequent lift. Each project should be studied to optimize the benefits of various lift thicknesses. Thicker lifts mean longer exposure times, but fewer lift joints and fewer potential seepage paths. Thinner lifts result in more potential lift joints, but allow the joints to be covered sooner, resulting in improved bond. Mixture proportions will also affect the workability and, consequently, the ability to achieve uniform density for the full lift thickness. The sloped layer method seeks to optimize the exposure time versus volume of each lift placed to achieve one thick layer with a large volume comprised of multiple 12 in. (300 mm) compacted layers before the preceding lift has reached its initial set.

At the start of extremely rough foundations and where the foundation has deep holes that have not been filled with dental or leveling concrete, a front-end loader, excavator bucket, or conveyor can be used to reach the placement site to deposit material. Conventional concrete can also be used to achieve a level working area to start RCC placement.

A small dozer (2 tons [1.8 metric tons]) is needed to start the foundation and for tight conditions. A small dozer is generally capable of spreading RCC at a rate of approximately 300 yd<sup>3</sup>/h (230 m<sup>3</sup>/h). Undersized dozers decrease productivity if the RCC is dumped in large piles.

**6.4.5 Sloped layer placing method**—The sloped layer method (SLM), shown in Fig. 6.10, is a more recent innovation in RCC placing that addresses concerns for maintaining the integrity of lift joints. This is particularly important for large dams when it is impractical to place subsequent lifts before the previously placed lift has reached its initial set. SLM was first conceived during the construction of Jingya Dam in China (Forbes et al. 1999). The SLM was developed out of necessity when the time to place subsequent lifts of RCC became too great due to the large volume per lift of RCC. Instead of one large volume of RCC per lift placed over one

shift or more, 10 small-volume lifts of RCC are placed quickly and advance over a longer duration. The SLM involves placing multiple lifts of RCC on slopes from 1:10 to 1:40 that are subsequently built up to a single layer, up to 10 ft (3 m) thick (Forbes 1999). The advancing 12 in. (300 mm) lifts are placed from one abutment to the other between formed upstream and downstream faces of the dam. The key to successful placing with the SLM is to maintain the volume of each layer small enough to ensure all lifts are placed before the initial set of the preceding lift. Changing the slope of the layers can alter the volume per lift, and thus the time interval between each placement. The top lift surface of the massive lift is essentially flat and treated by green-cutting followed by a bonding layer of mortar, similar to typical RCC practice for mature surfaces. The SLM method is somewhat related to the Japanese horizontally-placed RCD method and the traditional stair-step method of placing conventional mass concrete. A series of feather edges at the top and bottom of each sloped layer are treated by trimming, special placement procedures to prevent crushing aggregates, or both.

There are several advantages of SLM placing. Placement rates have been shown to increase by 30 to 50% by elimination of time-consuming lift surface preparations. The 12 in. (300 mm) lifts are placed and compacted rapidly, before they have reached initial set, eliminating lift surface cleanup and bonding mortar. The 10 ft (3 m) lift of RCC decreases the number construction joints by up to 90% and permits lift surface cleanup and placement of bonding mortar directly in front, but does not delay the advancing RCC. Critical path items, such as lift surface cleanup, curing, and erecting formwork can be carried out independent of the RCC placing. The number of lifts and slope can be adjusted to fit different form heights. The SLM has also been shown to work well with GERCC for both upstream and downstream faces. The exposed surface area of green RCC is decreased, reducing the amount of RCC that might be damaged (and thus removed) in inclement weather. The lower notch over the RCC placement can be used to pass sudden overtopping floods while keeping equipment safely above the surface.

Although SLM can be used to increase productivity, it should not be used as a corrective action for an undersized plant. The SLM can be used with a typical 1 to 3% crest fall for construction drainage purposes, though this requires somewhat more advanced surveying techniques. Form bracing should be capable of resisting the static and dynamic loads of up to 10 ft (3 m) of freshly compacted RCC. In addition, the SLM may limit the options of downstream forming methods, and finishing of horizontal surfaces of RCC may be more difficult. The RCC mixture should be cohesive and not segregate during the spreading process.

## 6.5—Compaction

**6.5.1 Roller selection**—Maneuverability, compactive force per unit of drum width, drum size, vibration, frequency, amplitude, operating speed, availability, and required maintenance are all parameters to be considered in the selection of a roller. The compactive output in volume of concrete per hour obviously increases with physical size and speed of

the roller. Larger-size rollers do not necessarily give the same or higher density than smaller rollers with a greater dynamic force per unit of drum width. Project size, RCC mixture workability, lift thickness, extent of consolidation due to dozer action, and space limitations will usually dictate roller selection. Large rollers cannot operate close to vertical formwork or obstacles, so smaller, hand-guided compaction equipment is usually needed to compact RCC in these areas. If a slipformed or precast facing system that has an interior face sloping away from the RCC is used (Fig. 5.5(e)), large rollers can operate adjacent to the facing.

The dynamic force per unit of drum width or impact per unit area on tampers is the primary factor that establishes effectiveness of the compaction equipment. Most experience shows that rollers with a higher frequency and lower amplitude compact RCC better than rollers with high amplitude and lower frequency, although acceptable results have been achieved on some projects using rollers with both high frequency and amplitude. The use of rollers that have more than one setting of amplitude and frequency provides flexibility in determining the best combination for the RCC mixture being used on a project. The typical compactor is a 10 ton (9 metric ton) double- or single-drum roller with a dynamic force of at least 450 psi (3 MPa). These rollers are typically used for compaction of asphalt and granular materials. Larger 15 and 20 ton (14 and 18 metric ton) rollers with more mass and size, typically used with rockfill construction, have been used with RCC, but they usually have larger amplitudes, lower frequency, and are less suited to the aggregate grading used in RCC. Achieving required density and a good lift-joint interface is more difficult with these larger rollers. The vibration mechanism should automatically disengage when the roller is stopped. Continued vibration in one location will cause displacement of material beneath the roller and raveling along exposed edges.

In tight areas, such as adjacent to forms and next to rock outcrops, large power tamper jumping-jack compactors are most suitable. They are mobile and can provide high-impact energy to produce good density. They usually, however, do not leave a smooth surface, and can sink when tamping RCC placed over an excessive thickness of wet bedding mixture, when tamping RCC with excess water, or when compacting along an unrestrained lateral face or along a conventional concrete mixture that has not lost its slump. Jumping-jack type compactors and heavy vibrating plates can be effective in achieving the required density throughout the lift, as long as lift thickness is not excessive. They may require multiple passes. Walk-behind vibrating plate compactors typically used for asphalt are generally effective only for surface compaction. They are often used to close the surface disrupted by power tampers. Walk-behind rollers are not very effective in most cases unless they can produce a compactive effort of approximately 350 psi (2.5 MPa) of dynamic force of drum width. Four to six passes of this type of roller on 6 to 12 in. (150 to 300 mm) thick lifts usually results in suitable compaction for tight areas, with densities approximately 98% of that achieved with large rollers.

At Burton Gorge Dam in Australia, 100% compaction was achieved with a small dozer in the top portion of the dam by modifying the mixture with a retarder, using a wetter RCC consistency and rapid placing (one lift per 1 to 4 hours), and rigorously tracking the 12 in. (300 mm) thick lifts as they spread. This resulted in densities that reached the theoretical air-free density of the mixture. Thorough dozer tracking the same mixture at a drier consistency and without retarder, with mixtures less than approximately 30 minutes old, achieved densities in the range of approximately 96% of the theoretical air-free values. Roller compaction was then required to achieve a higher final density.

While compaction on a trial basis with rubber-tire rollers has produced high-density RCC similar to that achieved with the vibratory roller, the degree of bond achieved at the interface of the RCC layers is questionable. Caution is advised using this equipment until its performance has been better evaluated. Rubber tire rollers have been effective in sealing, smoothing, and tightening the surface of mixtures that are susceptible to damage and that exhibit surface checking after final drum rolling.

**6.5.2 Minimum passes and lift thickness**—The minimum number of passes for a given vibrating roller to achieve specified compaction depends primarily on the RCC mixture workability and lift thickness. The maximum lift thickness will be governed more by how fresh the mixture is at the time of compaction, by gradation, and by the effectiveness of the dozer while spreading than by the number of roller passes. As a general rule, the compacted thickness of any RCC lift should be at least three times the diameter of the NMSA.

The required number of roller passes should be determined or verified in Chapter 7. Some compaction specifications require the first pass to be in the static mode to initially consolidate the RCC and prevent the roller from bogging down with wetter-consistency mixtures. Compaction of drier mixtures may begin with the vibrating mode. The frequency and amplitude settings may have to be adjusted depending on the workability of the mixture. The most effective compaction typically occurs with a high frequency on the order of 1800 to 3200 vibrations per minute, and with low amplitude, on the order of approximately 0.015 to 0.030 in. (0.4 to 0.8 mm). The transient loading and vibration result in consolidation of wetter-consistency mixtures with a measurable Vebe time. The same frequency and amplitude ranges have also been very effective with compaction of drier-consistency mixtures.

Typically, four to six passes of a dual-drum 10 ton (9 metric ton) vibratory roller will achieve the desired density for RCC lifts in the range of 6 to 12 in. (150 to 300 mm) thick. This assumes compaction in a timely manner with appropriate equipment. Over-compaction or excessive rolling should be avoided. Excessive rolling may reduce the density in the upper portion of the lift. Compaction in thick lifts after spreading in thinner layers can be effective with some RCC mixtures. This procedure requires an RCC mixture with a Vebe time in the 10- to 30-second range to achieve effective compaction by the dozer during spreading. Also, it may require a retarded set RCC mixture and roller passes on the top layer of the lift.

**6.5.3 Timing and procedures**—The appearance of fully compacted RCC depends on the mixture proportions. Mixtures of the wetter consistency usually exhibit a discernible pressure wave in front of the roller. Mixtures that have more paste than necessary to fill aggregate voids and a wetter consistency will result in visible paste at the surface that may pick up on the roller drum, depending on the constituents and plasticity of the paste. If the paste content is equal to or less than the volume needed to fill all the aggregate voids, rock-to-rock aggregate contact occurs, and a pressure wave may not be apparent. This can also occur if the mixture is simply too dry to develop internal pore pressure under the dynamic effect of the roller.

Compaction should be accomplished as soon as possible after the RCC is spread, especially in hot weather. Typically, compaction is specified to be completed within 15 minutes of spreading and 45 minutes from the time of initial mixing. Substantial reductions in strength values can be expected if the RCC is compacted when it is more than approximately 30 to 45 minutes old, and the mixture temperature is approximately 70°F (21°C) or higher. These times can be increased for RCC mixtures with extended set times due to pozzolans, admixtures, or cooler temperatures.

The fresh RCC mixture surface should be spread smoothly so that the roller drum produces a consistent compactive pressure under the entire width of the drum. If the uncompacted lift surface of less workable RCC is not smooth, the drum may over-compact high spots, and under-compact low spots.

Each RCC mixture will have its own characteristic behavior for compaction depending on temperature, humidity, wind, mixture workability, aggregate fines content and plasticity, overall gradation, and the NMSA. Generally, RCC mixtures should compact to a uniform texture with a relatively smooth surface. In general, the material should not pick up onto the roller drum, nor should there be free surface moisture or pumping of excess water from the mixture. Minor damage from scuff marks and unavoidable dozer tears in the surface of a freshly compacted lift can usually be immediately rolled with the vibratory drum in a static mode or with a rubber tire roller. If the mixture was sufficiently fresh and moist and is rerolled before initial set, an acceptable condition will result. If the mixture is too old, severely damaged, or if the lift immediately below has hardened, the rerolled RCC may look acceptable, but should be rerolled. Recompact RCC that is too old or damaged can and should be blown off by an air hose used for general cleanup of loose debris on the lift.

## 6.6—Lift joints

**6.6.1 Lift horizontal joint development**—Horizontal joints are inevitable in mass RCC because of its layered or lift method of construction. RCC may be compacted in individual lifts, or several layers may be spread before compacting them as one lift before initial set of the RCC. For sliding stability, joint shear strength, or water-tightness, designs usually require clean and relatively fresh joint surfaces with good bond. This is typically done by suitable large vacuum truck or air-blowing the surface with a wand. Some tests have

shown that sandblasting at 24 and 72 hours after placing can actually reduce bond (Dolen and Tayabji 1988).

When an RCC lift is not covered with additional RCC before it reaches initial set, a cold joint is formed. A cold joint can be generally characterized by either initial setting time or by joint maturity, which is a result of the average ambient air temperature (AAAT) and time of exposure (TE). Joint maturity is expressed in degree-hours, and is calculated as

$$\text{Joint maturity in } ^\circ\text{F-h} = \text{AAAT} \times (\text{TE})$$

For example, for 14-1/2 hour exposure at an AAAT of 70°F

$$\text{Joint maturity} = (70) \times (14\text{-}1/2 \text{ hours}) = 1015^\circ\text{F-h}$$

Degrees Fahrenheit-hour can not be exactly converted to degrees Celsius-hour, or vice versa, without first converting the temperature.

$$\text{Joint maturity in } ^\circ\text{C-h} = [(\text{AAAT} \times 1.8) + 32] \times \text{TE}$$

The setting time of RCC is somewhat more complex to determine. Many RCC mixtures have high percentages of fly ash, retarding admixtures, and cool placement temperatures, all of which may delay initial setting. The standard test procedure for initial setting is a penetration test that may not be as reliable for RCC due to its stiff consistency.

Joints are also sensitive to the quantity and characteristics of the cementitious material and the effectiveness of set-retarding admixtures. Each situation is different, but at an approximate AAAT of 70°F (21°C), a cold joint usually begins to occur in nonretarded RCC by approximately 4 hours, and has most likely developed by 6 hours. A joint that has been exposed less than 6 hours before being covered by the next lift will have adequate shear strength, but it may not be watertight unless it is clean and covered with a high-slump bedding mixture or high cementitious-content RCC mixture at a maturity of 500 to 1500°F-h (260 to 815°C-h). After approximately 500°F-h (260°C-h), a bedding mixture may be necessary to achieve the required shear or tensile strength. The exact maturity limit for each project depends on the mixture and design requirements.

Not all RCC mixtures require strict limits for lift surface maturity. The average lift surface exposure for the high-pozzolan mixture at Upper Stillwater Dam averaged approximately 1000°F-h (220°C-h) due to the large size of the dam and construction schedule. The high-paste mixture was retarded due to the high percentage of pozzolan, the low placing temperature, and the use of a chemical water-reducing admixture. The lift joint strengths exceeded the design requirements in both direct tension and shear without the use of any supplemental bonding mixtures (Dolen 2003).

High dams, and those where joint shear strength is critical to stability and safety, should have design assumptions for joint shear strength confirmed with shear tests of the RCC to be used, the conditions to be encountered, and the construction

controls that will be enforced. Initial design assumptions can be based on extrapolation from tests, evaluations, and successful design assumptions from previous projects. Example data are contained in Chapter 4. The issue is discussed further in Chapter 5.

Designers generally have found it prudent to require the bedding mixture (or higher paste-content RCC) after a lift has been exposed for approximately 12 to 24 hours, regardless of the surface maturity. Other designs have found it prudent to use bedding in a systematic manner for all or a portion of all lifts.

**6.6.2 Lift-joint treatment**—Lift joints should be kept continuously moist and protected from drying or freezing prior to placing the next lift and for curing of the final surface. The surface should be clean and at or near a saturated surface-dry (SSD) condition just before placing the next layer of RCC. Tests and experience have shown that allowing the surface to dry back to just under an SSD condition, as indicated by a change in color from dark to lighter, will greatly facilitate cleaning by air blowing, and will not reduce joint quality for most RCC. Some tests have even shown a slight increase in joint strength (Dolen and Tayabji 1988). Wetting, but not ponding, the surface after final cleaning and just before spreading the next layer of RCC is considered good practice.

If the surface is more than 1 to 2 days old and has become sufficiently hard, high-pressure water washing may be necessary if air blowing alone does not adequately clean off damage, contamination, and laitance that may be present. Water washing can only be used after the surface has hardened. Sandblasting is generally not advised or necessary.

Properly proportioned RCC mixtures generally do not bleed or develop laitance at the surface. An exception is very wet mixtures and some cases of dry mixtures after days of moist cure. If there is no weak laitance, coatings or deposits, or other contamination at the surface, lift-joint cleaning typically required with conventional concrete is not necessary. Although there is some debate, minor intermittent laitance that may occur in some situations is generally not removed.

If the construction joint exposed to an average ambient air temperature of 70°F (21°C) is between 500 and 1500°F-h (150 and 450°C-h) old, and if it has been kept clean and moist throughout its exposure, joint treatment is not always necessary. If the surface has been contaminated by dirt, mud, or other foreign elements, the contamination should be removed.

If the same surface has been allowed to dry out, exceeded approximately 1000°F-h (300°C-h) of maturity, or became damaged, it should be cleaned, and may require a full or partial bedding mixture before placement of RCC. The 1000°F-h (300°C-h) used herein is an example. Each project should set limits appropriate to meet the design criteria.

The practice of requiring a thin layer of highly workable mortar as bedding over all lift surfaces is routine in Japan, and has also been used at Elk Creek Dam. The RCC layer is spread over the bedding while the bedding still retains its slump or workability, and the RCC is then compacted into the bedding. The bedding mortar can be spread with brushes

on small tractors at Elk Creek Dam, and was applied by shotcrete procedures at Zintel Canyon Dam.

Many RCC projects have used a highly sanded conventional concrete or mortar mixture for bedding with good results. The mixture should have at least a 6 in. (150 mm) slump and be significantly retarded using admixtures. The bedding layer should be thick enough to fill in irregularities without being too thick. Where concrete is used, 3/8 to 3/4 in. (9.5 to 19.0 mm) maximum size aggregate is desirable. The bedding concrete thickness should average the dimension of the largest aggregate particle in the mixture. Where mortar is used for bedding mixtures, the thickness is generally approximately 1/4 in. (6 mm). Compressive strength for bedding mixtures should be greater than the RCC. Excessive thickness of bedding can result in pumping and difficulty compacting the overlying RCC. Cores have consistently shown that the use of bedding mixtures bonds the RCC layers.

Each project should be evaluated individually for bedding mixture types and requirements. Where bedding has been used over the entire surface of every RCC layer, it has basically been to achieve better joint interfaces throughout the dam, enhance shear and tensile capacity at the lifts, and provide added protection against lift-joint seepage. On other projects, bedding mixtures have been used when and where it has been determined to be necessary to achieve the required safety factor and seepage control. The width of bedding near the upstream face should be determined by the designer.

## 6.7—Contraction joints

**6.7.1** Contraction joints are an important part of the design of many RCC dams for thermal stress relief and to control seepage. Contraction joint construction can have a minimal to significant impact on production and quality of RCC placement. On RCC dams with a short crest length or small volume, installation of contraction joints can slow production significantly, which can reduce the benefits of fast placement of RCC. The contraction joint design feature selected should compliment the design methodology selected, as discussed in Chapter 5. Seepage control includes many methods such as construction of a contraction joint by inducing a discontinuity in the dam, placement of an upstream impermeable membrane, construction of a reinforced concrete upstream face, and no specific measures.

Foundation features, particularly rock edges, and abrupt changes strongly influence shrinkage crack locations sometimes beyond designed control joint locations. Contraction joint construction ranges from relatively simple, surficial crack and seepage control, to detailed joints with water stops, drain holes, and grout tubes. Surficial crack and seepage control construction includes formed control joints using chamfer strips as crack inducers. Crack inducers can be installed by placing 1-1/2 by 1 in. (40 by 25 mm) wood strips on the upstream forms. The control joints can then be sealed or treated with a backer rod and a joint sealer. A typical control joint treatment detail is shown in Fig. 5.4.

A detail of contraction joints consisting of a waterstop and drain is shown in Fig. 5.3. The waterstop is generally placed in conventional concrete at a specified distance from the

upstream face of the dam, and joint filler placed upstream and downstream of the waterstop. A frame with a roll of waterstop is frequently mounted to the upstream face forms to keep the material out of the construction area. For contraction joints with drain holes, the drain holes are formed as the RCC is placed, and an outlet pipe is connected to the drainage gallery.

The contraction joint through the RCC mass had been formed by either setting a crack-inducing plate braced on the surface during spreading, or inserting a plate throughout the loosely spread, uncompacted or compacted RCC. The sequence for installation of the crack-inducing plate is as follows: 1) spreading RCC to the contraction joint alignment; 2) setting a vertical form plate for the joint with some external bracing to maintain the plate vertical; and 3) spreading RCC on the opposite side of the vertical plate with manual labor around the plate. Plastic is usually placed around the vertical plate and the metal plate is removed, leaving the plastic in place as a bond breaker.

An alternative method to induce a contraction joint through the RCC mass has included using a vertical plate on a vibrator attached to a backhoe, or using a manually operated jackhammer. The galvanized steel plate is vibrated into place and left in the RCC as a bond breaker. Plates inserted before RCC compaction may be quicker to install, but tend to wander from a specified line. If a more definitive contraction joint is desired, it is recommended to install the crack inducers after compaction (Fig. 6.11).

**6.7.2 Grouting contraction joints**—To date, few RCC dams have required grouting of contraction joints. With the advent of much larger dams, arch RCC dams, and rehabilitation of existing dams, contraction joint grouting may become necessary. Both transverse and sloping longitudinal contraction joints were planned and constructed at Meil Dam (Marulanda et al. 2003). The transverse contraction joint spacing was reduced from the original 200 ft (60 m) spacing to 60 ft (18.5 m) to minimize thermal strains and decrease costs for cooling the RCC. These contraction joints include PVC seals at the upstream face of the dam. The sloping, longitudinal contraction joint was constructed in the lower third of the dam and included embedded pipes for post-construction grouting, when necessary.

Both longitudinal and transverse contraction joints were installed at Pueblo Dam spillway stability buttress to prevent foundation movement. The contraction joints were formed with steel plates inserted in every other lift of RCC after compaction. Joint displacement meters were installed during construction across the contraction joints so that the maximum opening could be monitored pre- and post-grouting. Contraction joints were isolated by drilling vertical holes through the joint and plugging them with a polyurethane grout. A manifold and header system placed in the RCC allowed grouting from the bottom of the joint to displace water upward with mixtures ranging from 2:1 initially to 1:1 or 0.8:1 for the grout in the joint (Aberle 2000).



Fig. 6.11—Crack inducers inserted by vibrating plate on front end loader, Miel I Dam, Colombia. (Photo courtesy of INGETEC S.A., 2002.)

## 6.8—Forms and facings

**6.8.1 General**—Numerous methods of constructing the upstream and downstream faces of RCC dams have been adopted since the first RCC dam was completed in 1982 (Arnold and Hansen 2002). Large surface areas that are not horizontal, such as the upstream and downstream faces of dams, can be shaped to almost any desired slope or configuration, but special consideration should be given to anchorages, appearance, and technique. A review of facing methods of RCC dams constructed through 2003 reveals typical methods and some recent trends (MDA & Associates 2003). The most common facing method for both upstream and downstream facing is conventional concrete, accounting for approximately 50% of all dams constructed. Approximately 20% of the RCC dams are using RCC placed directly against forms with an increasing trend toward the GERCC method. Various methods of precast forms with and without membranes account for nearly 20% of the upstream and approximately 10% of the downstream facing methods. The remaining facing methods include slipforming and reinforced concrete. The trends are generally similar for downstream facing, with approximately 13% of the dams using either compacted or uncompacted RCC. A few of the more common methods used to date are discussed briefly as follows, after general comments. These and other methods depicted in Fig. 5.5 and 5.6 for facing RCC dams are discussed in Chapter 5 and in Schrader (1993).

The height of overhanging sloping forms, such as for spillway surfacing or downstream face forms, restricts areas accessible to the vibratory rollers. These forms should, therefore, be limited in height or hinged at midheight to reduce the volume of concrete placed under the overhang by conventional methods. Conventional jump-form anchors may not have adequate embedment depth for form support when anchored in low-strength RCC, and special anchors are typically required.

Handling and raising conventional formwork may become the limiting factor in the rate of RCC placement. Near the top of a dam, where the volume of RCC per lift is low and the form area for upstream and downstream faces is relatively

large, more time may be required to set and move the forms than it takes to place the RCC.

**6.8.2 Formed faces**—Conventional forming can be used at the upstream or downstream face with the RCC or conventional concrete placed against the forms. Formed facing for both upstream and downstream facing accounts for approximately 70% of all RCC dams constructed through 2003 (including GRCC facing), with approximately half the dams constructed with some conventional concrete placed against the forms followed by RCC (Fig. 6.12). When RCC is placed directly against forms, the resulting RCC surface may have relatively poor quality (unattractive and porous) unless particular attention is given to the placement and type of mixture used next to the formwork. A conventional concrete with a set retarder has been used to provide a conventional concrete appearance and to provide freezing-and-thawing protection for the structure. Also, a set-retarded conventional concrete facing has been used to effectively reduce the number of horizontal joints in the facing by vibrating subsequent lifts of upstream facing together. The sequence of placement (RCC spread first, followed by facing concrete versus stacking facing concrete, and then spreading RCC) has been performed on numerous projects. Both methods have benefits and potential problems associated with the procedures. Placement of RCC first has the benefit of more rapid construction, which can improve other aspects of RCC construction. The lateral edge of the RCC and the quality of the RCC-concrete interface are of concern, however. Stacking concrete against the form followed by RCC may be somewhat slower, and special workability properties of the facing concrete are needed. Compaction of RCC on the facing concrete can cause deformation of wetter-consistency RCC and the facing concrete. Experimentation is ongoing to improve the RCC-conventional concrete interface.

**6.8.3 Grout-enriched roller-compacted concrete**—GERCC is a relatively new method for constructing a dam facing, and accounts for a growing percentage of RCC dams. GERCC involves placing RCC loosely against the forms, followed by the addition of a fluid grout to fill voids and improve workability just before compaction/consolidation. The fluidized RCC is typically consolidated by large-diameter immersion vibrators adjacent to the forms and standard vibrators approximately 1 to 2 ft (0.3 to 0.6 m) away from the forms. Smaller compaction equipment may also be used closer to the forms. The GERCC method was first tried in 1987 at the cofferdam of the Yantan Dam in China in 1987, and further developed at Rongdi Dam (upstream facing) and Pudding Dam (upstream and downstream facing) in 1989 and 1992, respectively (Forbes 1999). Since then, nearly all RCC dams in China have used this method. The Olivenhain Dam, with a maximum height 318 ft (97 m) and a maximum length of 2586 ft (788 m), used a slightly different method in 2002. The GERCC method used at Meil Dam is shown in Fig. 6.13 though Fig. 6.16.

In the GERCC method, grout is typically poured over freshly placed RCC and allowed to penetrate the RCC before consolidation. At Olivenhain Dam, the grout was placed before the RCC. The grout mixture had a water-cement ratio



Fig. 6.12—Conventional cast-in-place concrete stepped facing, Toker Dam, Eritrea, Africa. (Photo courtesy of MWH Global, 2003.)



Fig. 6.13—GERCC: adding grout onto surface of unconsolidated RCC along upstream form, Kinta Dam, Malaysia (Forbes 2008).

(w/c) of approximately 1:1 by volume, and had a marsh cone viscosity of approximately 35 seconds. The amount of grout required per unit length of RCC facing varies with both the RCC consistency and the lift height. Typically, approximately 2 gal./ft (25 L/m) of grout is required for a mixture with a measurable consistency of 15 to 20 seconds, and approximately 2.5 to 3 gal./ft (30 to 40 L/m) is necessary for a mixture with a consistency in excess of 40 seconds. Water-reducing and set-retarding admixtures have been used successfully. Attempts to use air-entrained grout in GERCC were generally unsuccessful in obtaining air-void systems necessary for resistance to freezing and thawing (McDonald 2002).

GERCC has been consolidated with immersion vibrators ranging from approximately 3 to 6 in. (75 to 150 mm); the size depends on both the consistency of the RCC and the amount of grout added (Fig. 6.14 and 6.15). This results in a zone of GERCC of approximately 1.3 ft (0.4 m) thick normal to the face of the dam. After the addition of the grout, the



Fig. 6.14—GERCC: consolidating GERCC with hand-held immersion vibrators at upstream formed facing, Kinta Dam, Malaysia (Forbes 2008).



Fig. 6.15—GERCC: consolidating of GERCC by 6 in. (150 mm) gang-mounted immersion vibrators, Jianguya Dam, China (Forbes 2008).

resulting concrete may have a slump of 1/2 to 3/4 in. (5 to 20 mm). Trials should be performed to assure there is sufficient overlap of the radius of action of the vibrators to assure the GERCC zone is fully consolidated. Compaction should immediately follow consolidating with a 2 to 3 in. (50 to 75 mm) overlap of the enriched RCC (Fig. 6.16). The surface of GERCC may require cleaning before the next lift of RCC, similar to a conventional concrete facing. Tests by the U.S. Army Corps of Engineers (McDonald 2002) indicate that additional study is needed to optimize materials, proportions, and construction procedures that will provide air-void systems necessary for GERCC that is resistant to cycles of freezing and thawing.

**6.8.4 Precast concrete forms**—Vertical and very steep faces can also be constructed with precast concrete panels or



Fig. 6.16—Vibratory roller compaction at GERCC interface, Kinta Dam, Malaysia (Forbes 2008).



Fig. 6.17—Precast panels for upstream face of Willow Creek Dam, OR. (Photo courtesy of U.S. Army Corps of Engineers, 1982.)

blocks. Precast concrete panels (Fig. 6.17 and 6.18), consist of relatively thin, high-quality concrete slabs with integral or external supports, or both, for erection. These panels can incorporate insulation to protect the interior concrete in extremely cold regions. They can also include a heavy-duty flexible impervious membrane attached to the rear of the panel to provide watertightness. Of the 44 dams constructed using these methods, the height averaged approximately 175 ft (53 m), and the crest length averaged approximately 1130 ft (345 m) (MDA & Associates 2003).

**6.8.5 Uncompacted slope**—Uncompacted or compacted RCC is primarily used for the downstream face of dams, accounting for approximately 13% of the dams constructed through 2003 (MDA & Associates 2003). If no attempt is made to compact the edges of an RCC placement, the sides will assume a natural angle of repose of approximately 50 degrees (0.8H:1.0V) with crushed aggregate and 48 degrees (0.9H:1.0V) with rounded aggregate. This assumes reasonable care with spreading and compacting. Any means of containing loose concrete at the edge (for example, by forming the height of the lift, by supporting the edge by pins driven temporarily into the RCC, or by mechanical means) can be



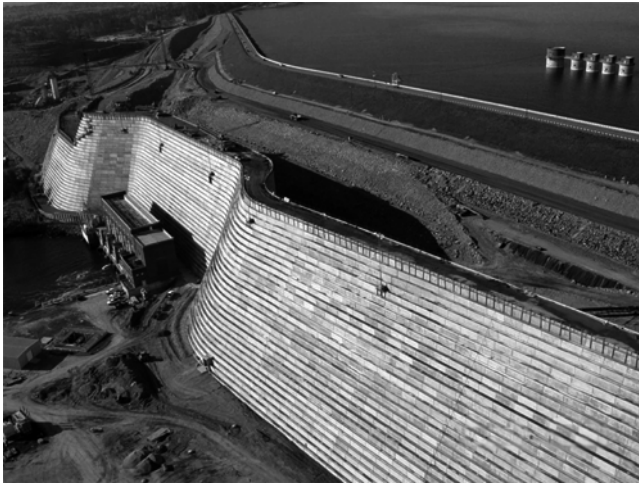

Fig. 6.18—Precast concrete forms for vertical upstream and stair-step downstream faces of Slauda Replacement Dam, SC. (Photo courtesy of Barnard Construction, 2005.)

used to construct steeper faces. On some projects, the exposed face of RCC has also been trimmed after compaction and before development of significant RCC strength.

**6.8.6 Curb forming**—One means of forming upstream and downstream faces is using powered curbing machines to slipform conventional concrete curbs or facing elements against which the RCC placement can be initiated within approximately 8 hours. This method is more applicable to wide valleys and large projects where the rate of rise of the RCC does not exceed the rate of slipforming. At Upper Stillwater Dam, it was possible to maintain an average production rate of 2 ft (0.6 m) vertical rise per day, with the curbs having enough time to develop the necessary strength. Nine slipformed facing dams constructed through 2003 had an average height of approximately 250 ft (75 m) and crest length of approximately 2300 ft (700 m).

### 6.9—Curing and protection from weather

After RCC has been placed and compacted, the lift surface should be cured and protected just as for concrete placed by conventional methods. The surface should be maintained in a moist condition, or at least so that moisture does not escape. It should also be protected from temperature extremes until it gains sufficient strength. RCC construction should typically stop when rain exceeds approximately 0.1 in./h (2 to 3 mm/h).

When vehicles are used on the lift surface during rain, the tires may turn the surface into a soft damaged material. This situation may require waiting for the RCC to harden so that extensive cleanup can be undertaken or the entire lift surface removed. When conveyors are used for delivery, and little or no vehicular traffic is required on the RCC, construction can continue with slight rainfall. This may require a decrease in the amount of mixture water used because of the higher humidity and lack of surface drying.

Immediately after an RCC lift has been compacted, the RCC will not become damaged by light to moderate rain as

long as there is no hauling or traffic on the surface. After a rain, hauling on the lift can resume only after the surface has begun to dry to a saturated surface-dry condition. A slightly sloped lift surface generally sloped down toward the upstream face of dams will aid in draining free water and speed resumption of placement operations.

Curing during construction has been accomplished with modified water trucks on larger projects, and with hand-held hoses for all-size projects. Trucks should be equipped with fog nozzles that apply a fine mist that does not wash or erode the surface. They can be augmented with hand-held hoses for areas that are inaccessible to the water truck. Provisions should be made for maintaining the damp surface while the trucks are fueled, maintained, and refilled with water. Care should be exercised so that the trucks do a minimum amount of turning (and disruption of) the surface. Maintaining access on and off every lift during construction can be a problem that makes trucks impractical. Water tanks and piping to transport water to the dam for distribution by sprinklers and hand-held hoses rather than water trucks have been used successfully on numerous projects.

The final lift of RCC should be cured for an appropriate time, generally in excess of 14 days. Membrane-curing compounds are not suitable because of the difficulty in achieving 100% coverage on the relatively rough surface, the probable damage to the membrane from construction activity, and the low initial moisture in the mixture. Curing compounds also do not provide beneficial surface temperature control that is associated with moist curing.

Unformed sloping surfaces, such as the downstream face of a dam, are difficult to compact and can be considered sacrificial and unnecessary to cure, provided this has been incorporated into the design. Uncompacted exposed RCC will be subject to raveling due to weathering, which can result in an unattractive surface. While the outside several inches will be incapable of achieving any significant strength or quality, it will serve as sacrificial protection and a moisture barrier for curing of the underlying interior RCC. Where unformed sloping surfaces have been trimmed, moist curing is necessary.

Protection from temperature extremes and sudden large fluctuations should be provided in environments where it is appropriate, just as for conventionally placed concrete. The lack of contraction or frequent monolith joints or both in RCC designs adds to the concern about cracking from early or rapid temperature drops, or both, because RCC has low modulus of elasticity and high creep rates at early ages. Very few recent RCC dams have been designed without transverse contraction joints.

The hydration heat generated by the RCC mass and the continuous placing sequence can combine to allow placement in cold weather, even when ambient conditions occasionally drop below freezing, provided that the surface stays at least 2°F (1°C) above freezing until it is covered by the subsequent lift. RCC construction in freezing weather may be hampered by freezing water lines, pumps, valves, and other equipment problems at the concrete mixing plant.

## 6.10—Galleries and drainage

There are several different approaches to constructing galleries in the dam mass. A critical aspect of any gallery-forming system is that sufficient rigidity is provided so that the RCC is fully compacted against the form. One method of constructing galleries is by conventional forming, and another is by placing gravel or fine aggregate in that part of the RCC lift where the required gallery is located, and later mining out this material to open the gallery. The interior surface resulting from the latter allows inspection of the RCC after all loose material is removed, but roughness from the fill material remains and some of it will adhere to the RCC. One method to overcome this is to use wood separators between the RCC and fill as each layer is placed. Segregation, rock pockets, and less-dense RCC are typical in gallery faces when forming and bracing is insufficient or drier consistency mixtures are used. Another method that has been effective is to place the RCC to the top of the gallery and then remove it with an excavator before it gains much strength. Precast concrete slabs are then generally used for the gallery roofs. Slipformed curbs were used as gallery walls at Upper Stillwater Dam. Precast concrete sections installed as permanent gallery linings have also been used. The design aspects of galleries are discussed in Chapter 5 and in Schrader (1985b, 1993) and Jansen (1989).

In constructing galleries, both the direct cost and the indirect cost due to slowed construction should be considered. Using the unformed fill method of construction adds approximately 10 to 15% to the placing time of the effected lifts, whereas more complex forming and precast methods may add 20 to 50%.

Gravel drains, porous concrete, and porous drain tubes have all been used to collect seepage and relieve pressure. In some cases, these techniques can be used instead of a gallery. Drain holes have also been drilled from planned RCC construction joints to galleries, and from galleries into the RCC. This drilling can start soon after the RCC is compacted and is normally done with rotary percussion drilling equipment.

## CHAPTER 7—QUALITY CONTROL OF ROLLER-COMPACTED CONCRETE

### 7.1—General

While quality control is customarily considered to be an activity performed during RCC placement, it should also be considered during design, planning, and the initial phases of construction of an RCC project (U.S. Bureau of Reclamation 1987).

**7.1.1 Quality control and design**—A structure should be designed with consideration of what will be required during construction to ensure that the required quality is attained. It is obvious that the design of projects where little quality control is anticipated should be more conservative than the design of a project where a very effective quality-control program will be implemented. For most projects, the quality-control requirements are specified in the contract documents or by separate agreement with a quality control organization. The preparation of these documents should be coordinated

with project designers so that the quality-control requirements are properly applied.

**7.1.2 Quality control goals**—The primary goals of any effective quality control program, regardless of the respective roles of the owner, engineer, and contractor are to:

- Promote understanding of the design and construction requirements;
- Improve communication of issues;
- Monitor performance;
- Reduce mixture variability; and
- Resolve outstanding issues.

A key element in attaining quality RCC is that the participating parties understand the requirements of the project. The routine process of submitting and discussing submittals required of the contract is one of many means to facilitate the necessary discussions. A clear method of communication should be established. Typically, chain-of-command structures are established to control and oversee what is said and done. A more responsive approach of direct communication has reaped benefits on many projects. Monitoring performance is primarily the inspection and testing process that is vital to determining the level of performance. It is the first step that is coupled with evaluation of data necessary to effectively resolve any problems. Reduced mixture variability enhances performance during construction by providing a consistent product from mixing to transporting and handling, placing, and final compaction. The majority of the remainder of this chapter deals with the specific elements involved with inspecting and testing of RCC operations.

**7.1.3 Quality control and production delays**—The benefit of quality control is to identify problems before they occur or sufficiently early in the process so they can be corrected. Tests must be performed, reported, and reviewed rapidly. The rapid placing rates and typical 20- or 24-hour/day construction timetables require careful attention and interaction between testing, inspection, and production personnel. If testing or inspection activities cause significant delays to any stage of RCC production, such as mixing, placing, compacting, or foundation cleanup, all construction may be affected and possibly stopped. The most common placement delays are usually due to problems caused by:

- Foundation preparation and cleanup;
- Joint cleanup;
- Hot or cold weather;
- Equipment breakdown;
- Insufficient materials; and
- Precipitation

**7.1.4 Quality trends**—Monitoring and reacting to the trend in performance data are preferable to reacting to an individual test result. The trend, identified by a series of tests, is more important than data provided by a single test. By continuously tracking trends, it is possible to identify detrimental changes in material performance and initiate corrective actions. Further, it is possible to modify the frequency of testing based on observed trends. For example, it is common to specify a high frequency of testing during the start of production and to later reduce the testing frequency as production

**Table 7.1—Typical quality control staffing levels**

	Small projects <10,000 yd <sup>3</sup> (< 7650 m <sup>3</sup> )	Medium projects 10,000 to 100,000 yd <sup>3</sup> (7650 to 76,500 m <sup>3</sup> )		Medium to large projects 100,000 to 500,000 yd <sup>3</sup> (76,500 to 382,500 m <sup>3</sup> )		Large projects > 500,000 yd <sup>3</sup> (> 382,500 m <sup>3</sup> )
	Single shift	Single shift	Double shift	Single shift	Double Shift	Double shift
Personnel	2	3	6	4	8	20

stabilizes. Once the production develops a manufactured process that is deemed stable, testing and inspection become more of a validation process to the design requirements.

## 7.2—Activities before RCC placement

**7.2.1 General**—RCC placing rates can be significantly higher than those for conventional concrete. Placing rates in excess of 1000 yd<sup>3</sup>/h (760 m<sup>3</sup>/h) have been achieved on projects. Small structures have been constructed in only a few days or weeks. With such rapid placement rates or short-term construction periods, problems need to be evaluated and solutions implemented in a short period of time. Any problems that delay RCC placing essentially delay all production. Good communication between the owner, engineer, quality-control personnel, and contractor is essential, and should be established in advance of the work.

**7.2.2 Preparatory issues**—A key element in resolving potential problems in advance is to ensure that all participants understand the project requirements and procedures. Basic issues that should be considered in advance are detailed in the following.

**7.2.2.1 Staffing**—Sufficient laboratory and inspection personnel should be trained and available for the anticipated production operations. These two groups work together to ensure and validate conformance with the design specifications. It is critical that personnel be adequately trained and oriented to recognize acceptable and unacceptable processes and products. Credentials may include various testing certifications and experience. Efforts should include orientations so that all production and oversight staff are on the same page with regard to acceptability of operations. Many RCC projects require nearly continuous placement operations and staffing must be sufficient to keep quality-control personnel fresh and not overworked. Shift overlaps and transitions require advance planning. The personnel listed in Table 7.1 are typical quality-control staffing levels observed on various projects of various sizes. They include testing and inspection personnel.

**7.2.2.2 Testing controls**—The main objective of the laboratory and field testing is to produce timely, accurate testing results. Technicians should be trained in the proper use of the equipment and in the proper testing procedures. Certain controls should be developed to check for accuracy and repeatability. A procedures manual for large projects should be developed to lay out the policy for testing. Checks, balances, and the flow of critical data should be discussed. Databases that can check, store, and report testing can be very useful.

**7.2.2.3 Inspection controls**—The inspection staff should have project specifications, references, and critical guidelines compiled and available to review in the field. Inspectors need to be trained in the entire construction process developed for the project and the quality issues critical to design performance.

Appropriate inspection reports for the various items to be inspected should be developed.

**7.2.2.4 Facilities and equipment**—Appropriate testing facilities and equipment for the size of material and the frequency of testing should be available in advance of RCC-related work. This process takes time, and is generally underestimated. For larger projects, quality-control contracts should be awarded and given notice to proceed at the same time as the RCC contract. Facilities need to be constructed and equipment needs to be procured and calibrated. Equipment should be selected for the testing specified and additional necessary tests. The building should be designed based on the equipment layout and the testing process anticipated. Enough room should be provided to allow for an orderly flow of samples to be tested in the laboratory. A canopy attached to the building is usually necessary for large projects to allow as large as 1400 lb (635 kg) samples to be delivered to the laboratory. This allows the RCC to be shaded from direct sunlight, thereby preventing unnecessary drying out of the sample. Samples can quickly become unworkable for the fabrication of cylinders and other testing when tested in direct sunlight.

Certain test procedures are critical for construction to begin and continue uninterrupted. These procedures should be identified and backup equipment, such as density testing equipment, Vebe machines, and cylinder fabrication equipment, should be available. Table 7.2 provides a guide of typical testing facilities used on other projects. High production rates coupled with long-term strength requirements may require larger cylinder storage/curing rooms or provisions to transfer excess test cylinders to an offsite testing facility.

**7.2.2.5 Communications**—The design engineer and quality-control staff should meet with the production staff to review and discuss requirements and procedures for RCC material production, mixing, placement, testing, inspection, and job-site safety. These communication activities should be scheduled frequently, if not daily, to evaluate daily construction activity for the staff and to ensure that safe working conditions are maintained throughout the job. Adequate radio communication at the job site among key personnel of the production, inspection and quality control organization, and field engineer staff is critical for avoiding work stoppages and unnecessary removal of material.

**7.2.3 Production issues**—Quality-control issues that relate to the production of materials for RCC placement are shown in Table 7.3 as follows:

**7.2.3.1 Aggregate production**—Sufficient material of acceptable quality characteristics, grading, and uniform moisture content should be tested and stockpiled before starting RCC. The quality of material processed will have an

**Table 7.2—Typical laboratory facility for various project sizes**

	Small projects <10,000 yd <sup>3</sup> (< 7650 m <sup>3</sup> )	Medium projects 10,000 to 100,000 yd <sup>3</sup> (7650 to 76,500 m <sup>3</sup> )	Medium to large projects 100,000 to 500,000 yd <sup>3</sup> (76,500 to 382,500 m <sup>3</sup> )	Large projects > 500,000 yd <sup>3</sup> (> 382,500 m <sup>3</sup> )
Laboratory size	One converted semi trailer or storage container	Two converted semi trailers or storage containers*	Permanent structure approximately 2500 ft <sup>2</sup> (230 m <sup>2</sup> ) or four converted semi trailers or storage containers	Permanent structure 3750 ft <sup>2</sup> (350 m <sup>2</sup> )

\*One trailer for laboratory testing, and one for equipment storage and cylinder curing.

**Table 7.3—Sample quality-control tests and frequencies.**

Material tested	Test procedure	Test standards*	Frequency <sup>†</sup>
Cement	Physical/chemical properties	ASTM C150/C150M or equivalent	Manufacturer's certification or prequalified
Pozzolan	Physical/chemical properties	ASTM C618 or equivalent	Manufacturer's certification or prequalified
Admixtures	—	ASTM C494/C494M ASTM C260/C260M	Manufacturer's certification
Aggregates	Specific gravity—absorption	ASTM C127 ASTM C128	1/week initially, 1/ month
	Grading	ASTM C117 ASTM C136	1/shift or 1/day
	Moisture content	ASTM C566 ASTM C70	Before each shift, or as required
	Flat/long particles	ASTM D4791 CRD-C 119	1/week initially, 1/month
	Plasticity of fines	—	1/month or 10,000 yd <sup>3</sup> (7500 m <sup>3</sup> )
	Sand equivalent	ASTM D2419	1/shift or 1/day initially, 1/week
	Abrasion resistance	ASTM C535 ASTM C131	1/month initially, or as needed
	Clay lumps and friable particles	ASTM C142/C142M	1/week initially, 1/month
RCC	Consistency and density	ASTM C1170/C1170M	2/shift, or as required
	In-place density	ASTM C1040/C1040M	1/h or every 250 yd <sup>3</sup> (200 m <sup>3</sup> )
	In-place moisture (double-probe, nuclear gauge only)	ASTM C1040/C1040M	1/h or every 250 yd <sup>3</sup> (200 m <sup>3</sup> )
	Oven-dry moisture	ASTM C566	1/shift or every 1000 yd <sup>3</sup> (750 m <sup>3</sup> )
	Mixture proportions—RCC mixture variability	ASTM C172/C172M, C1078, C1079	1/week or every 5000 yd <sup>3</sup> (4000 m <sup>3</sup> )
	Temperature	ASTM C1064/C1064M	1 every 2 hours or every 500 yd <sup>3</sup> (400 m <sup>3</sup> )
	Compressive strength <sup>‡</sup>	ASTM C1435/C1435M	1/day or every 5000 yd <sup>3</sup> (4000 m <sup>3</sup> )
	Split tensile strength <sup>‡</sup>	ASTM C496/C496M	1/day or every 5000 yd <sup>3</sup> (4000 m <sup>3</sup> )
	Elastic modulus <sup>‡</sup>	ASTM C469/C469M	1/day or every 5000 yd <sup>3</sup> (4000 m <sup>3</sup> )
	Compaction <sup>§</sup>	ASTM D1557	Start of materials and RCC production and if changes in compaction characteristics are observed.

\*Other appropriate industry standards may be used.

<sup>†</sup>Frequency shown is example typical of thorough agency testing. On projects with less stringent designs, less frequent testing may be appropriate.

<sup>‡</sup>Some projects used approach of relying on control during construction to achieve required quality, making few cylinders and taking cores afterward for verification of material properties in-place.

<sup>§</sup>Some projects use this method for determining the moisture content and compaction characteristics of the mixture.

impact on the quality of the final product of RCC. Aggregates to be received from a local supplier should be checked for quality and reliability before the aggregates are received. Table 7.3 provides a list of potential tests that may be necessary to be performed during this production phase. Production should be continually monitored and adjustments made when quality variations are detected. Stockpile operations should be inspected to ensure that improper operations are not creating segregation and that stockpiles are oriented to prevent cross contamination and reduce fluctuations in aggregate moisture.

**7.2.3.2 Aggregate sampling**—Sampling needs to be done as per ASTM D75/D75M. Sampling devices that are

mounted at the end of the conveyor and sample all the way through the stream of aggregate are necessary for a representative sample. Two locations are critical for sampling. To monitor the efficiency of the crushing operation, sampling on a conveyor should be done just before it goes into the stock pile. This will monitor the performance of the crushing plant. To monitor the possibility of segregation when stockpiling, sampling should be done just before the product goes into a surge bin before entering the weigh batcher. This sampling point will indicate if there is segregation during the stockpiling operation.

**7.2.3.3 Stockpile temperature**—Monitoring the stockpile temperature is necessary when unusually warm or cold

ambient conditions develop during RCC production, especially when temperature constraints on the RCC are very stringent. Information on stockpile temperature may allow production adjustments that will allow placement to continue during periods of marginal temperature performance.

**7.2.3.4 Mixing plant sampling and calibration**—The mixing plant layout should provide easy access to aggregate stockpiles and methods of sampling all materials without interruption of RCC production. Sampling locations and equipment for cement, pozzolan, aggregates, and concrete should be determined to safely obtain representative materials. All equipment should be properly calibrated, and calibrations documented. Batching controls and output should be checked to confirm the plant's ability to meter and mix the fresh properties of RCC. The mixing time is critical for RCC and needs to be sufficient to ensure that the material is uniform and of the right consistency.

**7.2.3.5 Mixer uniformity testing**—Uniformity testing should be done in advance of the RCC test strips and RCC placement. Methods are based on ASTM C172/C172M, Annex A1 of ASTM C94/C94M, and CRD-C 55. These have all been used in modified form to conduct uniformity tests of fresh RCC, and to establish acceptable mixing procedures in the field. Uniformity testing samples the final product of RCC at the mixing plant at three different increments and measures the variability of the mixture to assess the thoroughness of the metering and mixing process. The following process is generally used:

1. A sample of the metered aggregate only is taken first to determine the aggregate gradation. The batch plant should be allowed to meter the aggregates only. Sampling the material may be done by reversing the belt and creating a stockpile, or just simply stopping the belt and sample from the belt. The results of this testing should fall within the established gradation band that is developed for the combined aggregate;

2. A second evaluation is to meter all of the fresh properties of RCC through the mixing plant. Batch style plants and continuous flow plants are different. The batch-style plants should be sampled from the first, second, and third portion of the batched load. The continuous flow plant should be sampled from a continuous length of conveyor belt or at the placement site where a designated volume of RCC can be sampled. Alternate considerations are presented as follows. Each of the three samples should be approximately 600 lb (270 kg). Proper sampling and handling techniques are critical to not influence the uniformity results. This exercise is very labor intensive and requires a lot of advanced planning. The following tests should be performed and repeated for the second and third sample.

- a) Perform one consistency test as per ASTM C1170, Section 9.1, Method A; determine the unit weight as per Section 9.2;
- b) Weigh two individual 30 lb (14 kg) samples of the composite mixture of RCC for moisture. Calculate the average of the two samples;
- c) For air-entrained RCC, perform air content of the full mixture using a standard pressure meter. The sample is consolidated by a vibrating table;

**Table 7.4—Uniformity testing**

Tests	Maximum allowable difference, %	ASTM Standard
Vebe consistency	15	ASTM C1170/C1170M, Method A
Vebe density	15	ASTM C1170/C1170M, Method A
Water content of full mixture, %	15	ASTM D2216
Air content, %	100	ASTM C231/C231M*
Coarse aggregate, %	15	ASTM C94/C94M
Fabricate compressive strength cylinders for 7-day break	25	ASTM C1176/C1176M or C1435/C1435M
Density of air-free mortar	2	ASTM C94/C94M

\*Pressure air content of RCC can be determined by rigidly attaching air meter bowl to a vibrating table and compacting mixture in two lifts under a 34 lb (15 kg) surcharge.

- d) Weigh 200 lb (90 kg) of material for coarse aggregate wash. Wash material over a No. 4 (4.75 mm) screen, until minus No. 4 has been washed through. Towel dry remaining plus No. 4 material until sample is at an SSD condition and calculate the percentage of coarse aggregate;
- e) Fabricate a total of two cylinders as per ASTM C1170 or C1435/C1435M. Cylinders should be cured as per ASTM C31/C31M. RCC cylinders should be kept in their plastic molds for a minimum of 2 days in the curing room, with lids fastened tightly, before stripping is done. Low cement-content mixtures are very unstable in their first couple of days. A special standard of care should be given to these cylinders. Test for compressive strength at 7 days, as per ASTM C39/C39M.

Table 7.4 summarizes typical results based on previous project criteria.

**7.2.3.6 RCC placement plan**—The details of RCC placement should be documented and discussed in detail. The plan should include preparatory operations, materials supply, RCC transportation, spreading, compaction, curing, cleanup, supply, and any other operation that may impact the planned rate of RCC placement. The plan should include a detailed listing of equipment, pertinent characteristics, and crew composition. In many cases, this discussion serves to resolve issues that may not have been extensively addressed in the contract documents.

**7.2.4 RCC test section and test strips**—One of the primary purposes for a test section is for the contractor to demonstrate equipment and procedures to be used for mixing, handling, and placing RCC and conventional concrete, and to prequalify compaction procedures and equipment. It also serves as a training and practice area for both quality-control and RCC production personnel. It is important to recognize that, especially if the section is small or full production equipment is not available, obtaining the same quality as can be expected under full production conditions will be difficult or impractical. A separate test section is preferred over starting immediately on the permanent work because the first placement is typically at a critical section of the structure, at its base.

Typically, the test section is two to four lifts high and includes at least one lift joint requiring joint surface cleanup. The facing system should also be evaluated in the test section. Test section construction should be staged so that numerous operations are not required at the same time. For example, surface treatments should be evaluated on one lift surface, facing construction on another lift surface, and compaction alternatives on yet another lift surface. The test section should be started on a firm foundation, often a lift of RCC used in calibration of the batching and mixing plant.

The workability and density of the RCC mixture are evaluated by laboratory testing, and any mixture proportion adjustments can be fine-tuned during construction of the test section. This may include adjusting the water content, cement plus pozzolan content, or fine-coarse aggregate ratio. The test section can also be used to determine field density requirements. Coring, sawing, test trenches, and demolition of the test section with heavy equipment provides a method of evaluating lift-joint quality, a critical feature of RCC dams. Cores representative of the test section mass may be difficult to recover at early ages. To increase core recovery, a number of measures have been successful. They include the use of drilling fluids, split core barrels, proper drill selection, and collar installation. Use of a split inner tube core barrel has been found to minimize drilling damage, particularly at lift joints.

A major goal in test section construction is to evaluate the RCC mixture performance (that is, mixture segregation, mixture proportions, and compactibility). For a number of projects, it was advantageous to evaluate mixture performance, including desired moisture content separately from and in advance of test section construction. This can be done by constructing test strips at placements of approximately one equipment width (approximately 10 ft [3 m]) extending 30 ft (10 m) or more in length (approximately two vibratory roller lengths) and not more than two lifts in thickness. Field maximum density (density versus roller passes) is measured on the test placements for all the compaction equipment. This operation allows early and independent evaluation of mixture handling characteristics and compaction performance and eases later test section activities by reducing test section evaluations to production and placement issues.

**7.2.5 Determining field density/compaction requirements—**It is common to perform field density tests to establish or verify density requirements for construction and for comparison with laboratory RCC mixture properties used for design. One approach for technical specifications is to use an in-place control section to establish the density required for acceptance. Later, additional density control sections may be done on a regular interval for the mixture used in RCC production. The following steps illustrate a maximum density determination:

1. Select the location and dimensions of the control section (that is, 100 ft [30 m] long and at least two roller widths wide);
2. Begin compacting the freshly placed RCC and test the wet density after every two passes until the density is no

longer increasing, or the increase is less than 0.2 lb/ft<sup>3</sup> (3.0 kg/m<sup>3</sup>); and

3. Perform sufficient wet density tests and determine the average maximum wet density (AMD) based on 10 tests.

The performance during construction is based on achieving 99% of the AMD obtained from the most recent control section. If the wet density fails the specified limit, the RCC should be rerolled within approximately 30 minutes after the failing test or, if necessary, the RCC should be removed.

The control section moisture content should be monitored. If the in-place moisture content changes by more than approximately 0.3% by mass, another control section is necessary to maintain the equivalent percent compaction.

**7.2.6 Checking compaction equipment—**Inspection personnel should check compaction equipment for compliance with specification requirements before the start of work. If there is reason to believe the equipment is not working properly, the equipment manufacturer should be consulted.

### 7.3—Activities during RCC placement

**7.3.1 General—**Inspection is the first opportunity to observe an RCC problem and institute measures to correct it. In addition to inspection activities, a comprehensive RCC testing program should monitor the aggregate properties, RCC mixture proportions, fresh concrete properties, hardened concrete properties, and in-place compaction. Examples of possible tests and test frequencies are given in Table 7.3. The frequency and extent of testing should be established according to the size of the project, the sensitivity of the design to variations in quality, and the rate of RCC production.

Fresh RCC properties may vary with daily, weekly, or seasonal fluctuations in ambient weather conditions. The variations generally affect water requirements, compaction characteristics during construction, and the quality of the concrete. Normally, construction activities continue throughout a variety of warm, cold, wet, or dry ambient conditions. Quality-control personnel should ensure that continuous adjustments in moisture and, if appropriate, other mixture proportions are made to adapt to these conditions. Communication between shifts about these adjustments is also important.

**7.3.2 Inspection—**Monitoring quality and verifying quantities are critical. Careful monitoring of these areas will help in eliminating variability and unacceptable material at the point of placement. This also serves as the verification of the process. A structure should be built to validate the designer's intent. Each point of monitoring should have inspection criteria and a remedy for each deficiency. This will help in unnecessary slowdown or shutdowns of the RCC process. The following sections contain areas of project monitoring. Projects with less stringent design may not need the amount of monitoring described herein.

**7.3.2.1 Batch plant monitoring—**The inspector in charge of the batch plant needs to verify this process through a series of daily inspections. The inspection should include verification of individual batching weights of the different products, such as cement, fly ash, and the aggregates and water for batch-style plants, or verification of the volumetric feed of materials through a continuous flow plant. Inspections should also

include moisture content of each aggregate, which is critical to recalculating the batched water. Verification of delivered cementitious materials should also be recorded and verified. The inspector should also evaluate the mixture for consistency and uniformity. Larger projects have a Vebe table at the plant to monitor consistency and density as necessary. This helps to produce an RCC product that is more consistent and relieve a lot of time trying to fix problems with consistency at the placement, when material is already on the ground. The consistency will differ from the plant to the placement due to the time taken to deliver the product. A correlation should be developed early on to understand these issues. For instance, if the placement is looking for a 25-second consistency time, the material will probably have to leave the plant at 20 seconds. Consistency times reflect the consistency or workability properties of the mixture, and are highly dependent on water content. Too much water can cause rutting and pumping and affect lift surface cleanup. Too little water can cause segregation and difficulty in achieving full compaction. These problems affect the strengths, densities, and lift joint cohesion and create other problems. Although consistency times do not directly report these characteristics, they are a useful tool in determining the desired RCC. Once the inspector and plant personnel have a trained eye for the necessary workability for compaction, the consistency time is useful for spot checks and record keeping of the mixture performance.

**7.3.2.2 RCC placement**—Placement inspectors have a wide range of activities. The number of inspections needed is dependent on the anticipated production rates and design features requiring monitoring, such as facing concrete, bedding, and precast panels. The actual placement inspection activity of the RCC should include lift thickness verification, compaction time, and the required number of roller passes. The rollers need to compact the fresh RCC before it becomes dry and unworkable. Inspectors should look for consistency and uniformity in the final in-place product of RCC. Communication between testing personnel on the placement is critical to the process of rapid construction of RCC. On large projects, a second inspector may be necessary to inspect other construction activities such as placement of bedding materials and concrete facing and forming. A third inspector may be used to evaluate lift surface treatment and cleanup that usually takes place on a different shift with a different crew for the contractor. Inspection as work progresses, rather than once a full lift is clean, is effective in helping production restart and continue efficiently. The inspection staff will double if two shifts are being used for the placement.

**7.3.3 Material testing**—All RCC materials should be checked to confirm that they meet the project specification requirements before use in the work. Table 7.3 summarizes typical tests and typical testing frequencies.

**7.3.3.1 Cement and pozzolan**—Cement and pozzolan are normally accepted based on manufacturer's certification. Tests may also be performed on grab samples during construction of large projects under their quality-assurance program.

**7.3.3.2 Admixtures**—Admixtures are normally accepted based on manufacturer's certification.

**7.3.3.3 Aggregates**—The moisture content, grading, particle shape, and the quality of the aggregates significantly affects the fresh and hardened properties of RCC. The grading of the combined sand and coarse aggregates affects workability and the ability to effectively compact or consolidate RCC. In addition to standard gradation analyses, the aggregate should be tested for its quality and variability compared with the specified or designed requirements. Fine aggregate testing may include testing for material passing the No. 200 (75  $\mu\text{m}$ ) sieve. Specific gravity is useful in monitoring the density of the fine and coarse aggregate. Other quality tests of aggregate may include the Los Angeles abrasion resistance or sodium sulfate soundness, which will monitor the quality and durability of the aggregate, and specific gravity, which will help ensure mining in a dense aggregate. Flat and elongated testing will help ensure that coarse aggregate particle shape is maintained.

Varying moisture in stockpiles will result in varying workability of RCC. An increase or decrease in moisture of a few tenths of 1% can change the compacting characteristics of RCC. Samples of aggregate, as batched, should be taken and tested at least once per shift to confirm concrete plant moisture meter readings and to calculate the actual amount of water being used in the RCC mixture.

**7.3.4 RCC testing**—A variety of RCC quality-control tests were developed to accommodate the wide range of consistencies, mixture proportions, and aggregate grading possible with RCC. Some tests are adapted from conventional concrete procedures, while others are adapted from soil cement or earthwork technology. There is no single set of tests that applies to all RCC mixtures and placing operations. ASTM standard test methods for RCC require that the concrete shall have a maximum size aggregate of 2 in. (50 mm). If the RCC has aggregate larger than 2 in. (50 mm), samples shall be obtained by wet sieving over a 2 in. (50 mm) sieve in accordance with ASTM C172/C172M.

**7.3.4.1 Consistency tests**—The Vebe (Fig. 7.1) or similar apparatus is used to measure the consistency of many RCC mixtures, but does not provide a measure of consistency for the drier or lower paste-volume RCC (U.S. Bureau of Reclamation 2005). When it is used for the more workable types of RCC mixtures, typical consistency times are 10 to 30 seconds (Cannon 1974). The Vebe consistency and density tests take approximately 15 minutes to perform after the sample is delivered to the laboratory. In some instances, Vebe tables at the plant and placement are useful. Placement consistency will be higher than those taken at the plant. A correlation early on will help. Plant tests are taken to ensure that the product is leaving the plant at the right consistency. Tests at the placement are the verification of the final in-place product. Testing at both points will help eliminate the possibility of removal of material at the placement. This testing is critical early on until the placement staff develops a trained eye for the RCC.

The standard Vebe apparatus for conventional no-slump concrete has been modified for RCC. Fresh RCC is placed in the 1/3 ft<sup>3</sup> (9.4 L) cylindrical steel container under a surcharge. The sample is vibrated until it fully consolidates

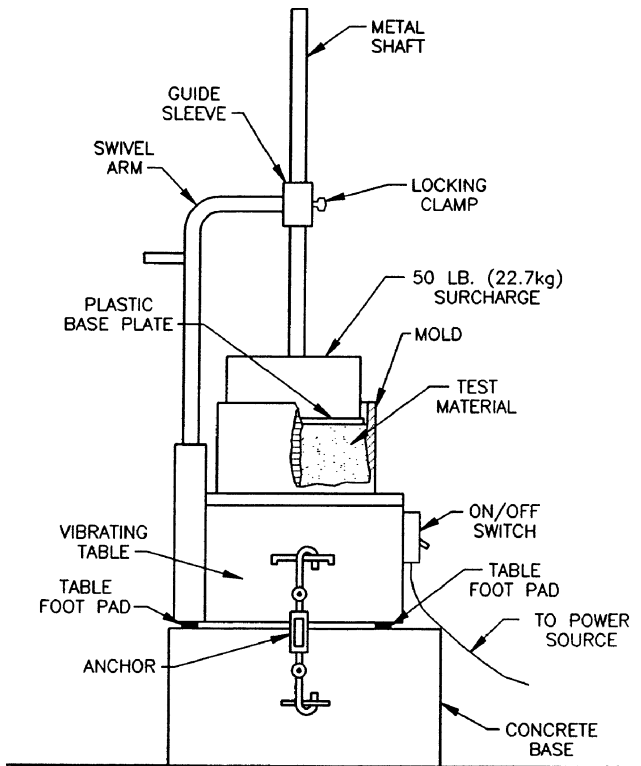

Fig. 7.1—Vebe consistency apparatus (ASTM C1170).



Fig. 7.2—Vebe consistency test time with ring of mortar on consolidated sample. (Photo courtesy of U.S. Bureau of Reclamation, 1985.)

under the surcharge. The Vebe consistency is the time it takes to fully consolidate the sample as indicated by a ring of mortar around the periphery of the surcharge (Fig. 7.2). The density of fresh RCC is determined from the consolidated sample. ASTM C1170 includes procedures for testing RCC with either a 27.5 or 50 lb (12.5 or 22.7 kg) surcharge. The U.S. Army Corps of Engineers (USACE 2000) recommends using the smaller surcharge.

**7.3.4.2 Density and air-void tests**—The maximum density of RCC is measured from fresh samples obtained at the mixing plant or from the placement and compacted according to standardized procedures.

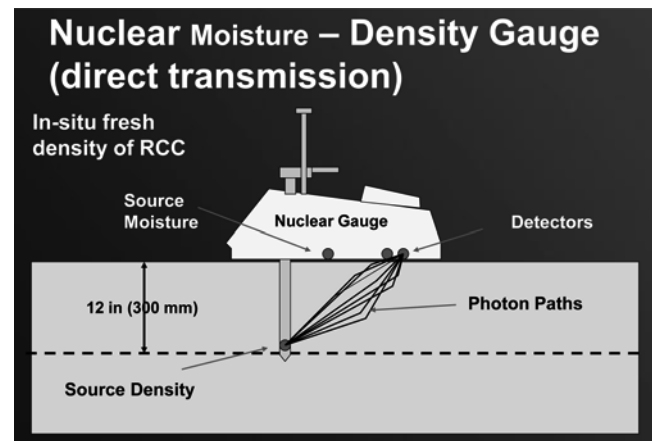

Fig. 7.3—Single-probe nuclear gauge. (Photo courtesy of Troxler Electronic Laboratories, 1981.)

The Vebe density test is used as a method to measure the degree of compaction or air void content. Air voids for both air-entrained and non-air-entrained RCC can be determined by compacting or consolidating the fresh RCC into a standard container rigidly attached to the Vebe table and determining the air content by the pressure method.

The in-place wet density of RCC is determined indirectly with a calibrated nuclear density gauge. Sand cone and balloon methods of determining density are generally not suitable because of the difficulty and time required to excavate the test hole with undisturbed sides. Two types of apparatus are commercially available for the nuclear test: a single-probe (Fig. 7.3) and a double-probe nuclear density gauge. Testing may take 5 to 15 minutes, depending on the number of positions that the gauge is rotated (for the single-probe device), the ease of driving the probe hole, and the number of depths at which densities are checked. In the U.S., the gauges must be licensed by the Nuclear Regulatory Commission (NRC) and operators must receive NRC-approved training.

Both the single- and double-probe gauge have limitations due to their design and geometry. The single-probe gauge can usually measure up to 12 in. (300 mm) depth. The single-probe gauge takes the average density of the lift from the bottom of the inserted probe to the top surface. The density result, however, is weighted to the more easily compacted top of the lift than the lower portion of the lift, which is more difficult to compact, and can contain segregated material with some RCC mixtures. A 10% drop in density in the bottom 2 in. (50 mm) of the lift may only be recorded as a 1% drop in overall density with the single-probe gauge.

The geometry-related problems of the single-probe gauge are avoided with the double-probe gauge. The density is measured horizontally from the source probe to the detector probe at the same depth. Thus, individual strata can be measured at different depths. The double-probe gauge can measure up to 24 in. (600 mm) depth. Though more desirable than the single-probe gauge, the double-probe apparatus is more costly, heavier, and more time-consuming to use. A significant difficulty with the double-probe gauge occurs if the two pilot holes for the probes are not properly aligned in the RCC. Due to the granular nature of RCC, driving two



parallel vertical holes in the RCC is difficult, and proper seating of a double-probe gauge requires more attention.

The density measured by nuclear gauges is affected by the chemical composition of the concrete constituents, and may not be the true density. The gauge should be corrected for chemical composition error by determining the true density of fresh RCC compacted to different densities in a rigid calibrated container according to ASTM C1040/C1040M or another acceptable standard, and comparing that density to the density indicated by the gauge. When testing RCC mixtures, particularly those with a NMSA greater than 2 in. (50 mm), the probe holes should be driven into the fresh concrete quickly so as not to disturb the in-place density of the concrete. Voids created by driving the probe through larger-size aggregate can give erroneously low density readings.

Density tests using the proposed equipment should be performed as soon as practicable, with consideration for safety and for not interfering with other placing activities. The contractor should be aware that nuclear gauges should be attended or secured at all times, typically requiring personnel and a small truck at the test location. The lift may be rerolled if it fails to meet the required density, provided that it has not yet set nor reached the time allowed before completion of compaction. Finish passes with the roller in static mode or with smooth rubber-tired equipment may tighten up the top surface before testing.

**7.3.4.3 Moisture and water content tests**—The moisture or water content is important for several reasons: 1) to determine the  $w/c$  or  $w/cm$  on projects that may use it in design or as a specification requirement; 2) to ensure the optimum or desired moisture content for workability and compaction; and 3) to use as one of the indicators of mixture uniformity. Moisture test methods include:

1. Chemical tests (ASTM C1079);
2. Drying tests (ASTM C566, D4643, and D4959); and
3. Nuclear tests (ASTM D3017).

Chemical and drying tests can be performed on samples obtained either before or after compaction. The samples should be representative of the actual production, particularly with respect to the mortar-aggregate ratio and the time the sample is obtained.

**7.3.4.3.1 Chemical tests**—Two chemical tests are given in ASTM C1079. Both procedures relate the water content of the concrete to the chloride ion concentration of the test sample either by volumetric titration or calorimetric technique. The methods require calibration for individual mixtures and materials, and recalibration for new reagents. A reasonably clean and constant laboratory environment is recommended for these test procedures. These procedures have not been used to a great extent on RCC projects.

**7.3.4.3.2 Drying tests**—Drying tests include hot plates, standard ovens, or microwave ovens to remove the water from a representative sample. The tests are adapted from soil and aggregate procedures. The test accuracy is affected by both evaporation and chemical hydration of cement. This, in turn, is a function of time, temperature, precipitation and humidity, mixture proportions, and materials properties (grading, absorption, and cement chemistry).

The test result is significantly affected by where and when the sample is obtained. A sample tested directly out of the mixing plant may not produce the same results as a sample tested after being spread and compacted by a roller. Consequently, the location for sampling should be specified. It has become common on some projects to test for moisture at the mixer to obtain an indication of how much water is being added or lost under construction conditions. Hot-plate and oven-dry moisture tests performed by the U.S. Bureau of Reclamation with samples obtained and tested immediately after mixing compared closely with the as-batched moisture content. In low-humidity, high-temperature ambient conditions, samples tested 1 hour after mixing lost approximately one-third of the as-batched moisture due to evaporation and hydration. Samples obtained immediately after mixing and sealed to prevent evaporation lost approximately 6% of the as-batched moisture 1 hour after mixing. The sample size for these tests was 10 lb (4.5 kg). Microwave evaporation tests are generally limited to mortar samples due to the potential for exploding aggregate and because large samples are needed to get reasonably accurate results. Large aggregate mixtures may require samples as large as 65 lb (30 kg). The hot-plate and oven-dry tests are the most common, reliable tests used for RCC.

**7.3.4.3.3 Nuclear test**—When used to determine moisture content, the nuclear gauge actually measures hydrogen content, which is in turn related to water content. The gauge reading should be adjusted or calibrated for any chemical composition error, similar to the density reading. The result is affected by stratification of moisture in the lift and may change with compaction by rollers or trucks, or from surface moisture changes due to precipitation, curing, or drying.

The nuclear gauge moisture content is normally determined on compacted RCC. The single-probe gauge tests moisture at the surface (backscatter mode), whereas the double-probe gauge tests moisture at depth with a direct transmission approach. Because the single-probe nuclear gauge tests only the near-surface moisture content, it is not reliable for determining in-place moisture content. The double-probe gauge can test the moisture content of RCC at depths ranging from 2 to 24 in. (50 to 600 mm). The moisture content should be computed as the average of the bottom, midpoint, and top of the lift with this gauge.

**7.3.4.4 Determining cement content**—ASTM C1078 and C1079 can be used to determine the cement and water content of freshly mixed concrete by chemical titration or calcium ion analyzer. The sample size and specifics of sample preparation have been modified to facilitate the procedure with some RCC mixtures. The heat of neutralization test (ASTM D5982) has also been used to determine the cement content of freshly mixed concrete, but it has resulted in problems of high variability and premature solidification of the sample with RCC on some projects. All methods should be calibrated for a given aggregate cement pozzolan, mixture water, and admixture. None of these methods is effective for determining the pozzolan content of concrete and, therefore, they are rarely used. It should be noted that

cement content is very difficult to obtain with mixtures incorporating limestone aggregates.

### 7.3.4.5 Evaluating RCC mixture proportions

**7.3.4.5.1 General**—Evaluating RCC mixture proportions has two main aspects: 1) establishing that materials enter the mixer with the desired proportions; and 2) evaluating the workability of the RCC and the uniformity (or variability) of the mixture proportions after it leaves the mixer or after it has been placed and compacted. An essential element of quality control is the monitoring of batch weights or proportioning weights during RCC production.

#### 7.3.4.5.2 Batch-type plant records and calibration—

The primary concerns with RCC, like any concrete, are ensuring batch constituents are properly proportioned within acceptable tolerances, matching aggregate feed rates and storage capacities to high production rates, finding the best batching sequence for each mixture, and getting all materials uniformly blended within a reasonable mixing time. The combined charging, mixing, discharge, and return time determines the maximum production rate. Mixture proportions are input from manual or computer controls. Actual and target batch weights of ingredients should be recorded electronically or on a printout for each batch.

**7.3.4.5.3 Continuous mixing plant records and calibration**—Mixture proportions are converted to a continuous feed rate in tons per hour (kilograms per hour). Materials used for calibration tests are accumulated over a fixed period of time rather than being measured individually for a separate batch. As with batch-type plants, materials may be individually fed into the mixer from separate bins, or they may be accumulated on a common final feed belt. This is determined by whether the mixer has, for example, one belt for all aggregate bins or multiple belts with one for each bin. Calibration with just one belt operating may not apply when the plant is in full operation with all feed belts operating. Weigh belts provide weight controls rather than volumetric control, and computer printouts have been used on some RCC projects and are recommended for quality control of this proportioning method. As with batch-type plants, a diversion conveyor belt is recommended to sample RCC at the plant without stopping production. Proper interlocks should be provided to prevent continued plant operation if one belt stops or slows. Also, as with batch-type plants, the continuous proportioning plant should be calibrated at the minimum, average, and maximum expected production rates. During production, it may be necessary to recalibrate the plant following a shutdown or if an unusual change in the mixture is noted.

**7.3.4.6 Temperature**—The temperature of RCC, when measured during placement, depends on the temperature of concrete ingredients, time to placement, handling and delivery methods, and the current ambient conditions. When a maximum or minimum temperature is specified, it usually is applicable just before or after compaction. The temperature is normally determined by thermometers or thermocouples embedded in the concrete.

**7.3.4.7 Making test specimens**—Six-inch diameter x 12 in. long (150 x 300 mm) cylinders and other sizes of RCC test

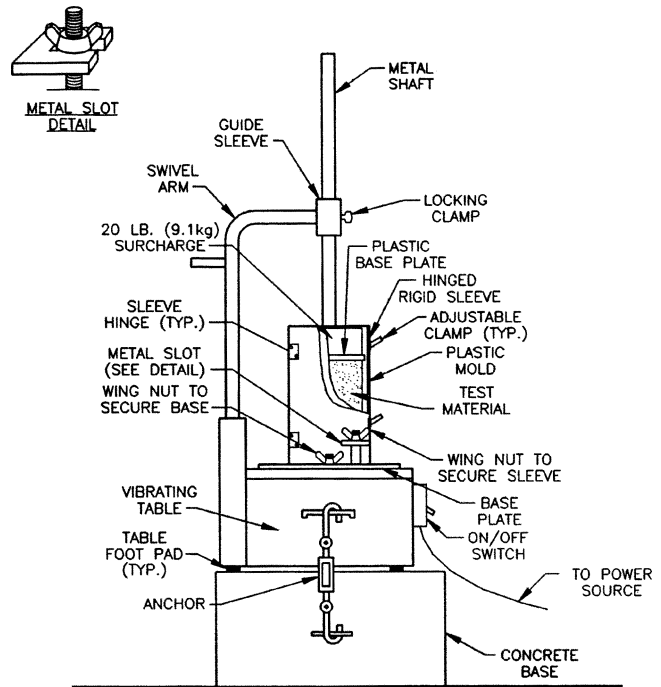

Fig. 7.4—Device for making RCC test cylinders with modified Vebe apparatus.

specimens should be made using procedures suited to the consistency of the mixture, the maximum aggregate size, and the number of samples to be made before the mixture begins to dry out. Test specimens should be compacted in rigid molds or in removable liners supported during compaction by rigid molds. Higher paste-content mixtures with a consistency time less than approximately 30 seconds are suited to consolidation by ASTM C1176/C1176M (Fig. 7.4). This procedure uses a vibrating table similar to the Vebe apparatus and a surcharge weight such as 20 lb (9.1 kg). The RCC is consolidated in three layers. Other surcharges and modifications have also been used.

Mixtures that do not respond at all to the Vebe test can be compacted by procedures using vibrating hammers in accordance with ASTM C1435/C1435M (Fig. 7.5). These hammers have been modified by securing a 5-1/4 in. (133 mm) diameter flat plate on the end and have become increasingly popular for preparing test specimens. The frequency and amplitude of the vibration approximates that of a vibratory roller. It can be used for RCC of all consistencies. If mortar appears around the plate at less than maximum 15 seconds per each of four lifts, the apparatus should be removed from the lift surface.

The modified proctor method of compaction (ASTM D1557) has also been used. The modified proctor method should be adjusted for use with RCC by changing the lift thickness and aggregate size from the standard procedure (Arnold et al. 1992). In addition, the compaction hammer tends to fracture aggregates and is slow.

Another cylinder preparation method consists of compaction in three layers with a pneumatic tamper with a 5-3/4 in. (146 mm) diameter smooth faced tamping foot. This method



Fig. 7.5—Making RCC test cylinders with vibrating hammer.

is typically used for lower-cementitious-content RCC mixtures (Schrader 1987b).

Regardless of the procedure used, it should be capable of compacting the test specimens to a density comparable with that achieved with the rollers in the field in a standard manner.

**7.3.4.8 Strength testing**—RCC strength test specimens may have extremely low early-age compressive strength, which makes handling, stripping, and capping difficult. Some mixtures have compressive strengths of only 200 psi (1.4 MPa) or less at 3 days of age. A procedure that minimizes the problem of handling and storing these cylinders is to compact the specimens in thin or precut metal, or PVC liners that are supported by rigid molds during compaction. The liner then stays on the sample until immediately before it is tested.

Because of the rapid rate of RCC production and the fact that most projects use design ages of 90 days to 1 year, RCC strength tests have limited use as a quality-control tool. By the time reliable results indicating a low ultimate strength are available, the project will have progressed well beyond where the questionable material was used or where any action can be taken. The information obtained from these tests is useful for monitoring the control maintained on the project, and is valuable documentation of the work similar to that performed for conventional concrete dam construction.

If strength testing is required, it is common to cast a set of test specimens from each shift or each day of production. Tests are normally performed at 7, 28, and 90 days, and extra specimens are often performed at 1 year on a weekly or monthly basis. Accelerated curing (ASTM C684) of cylinders and mortar cubes has been used in an effort to get an earlier indication of ultimate strength potential and variability. Accelerated curing appears to have more potential for success with higher-cementitious-content mixtures and conventional concrete aggregates, although standard procedures for RCC have not been developed.

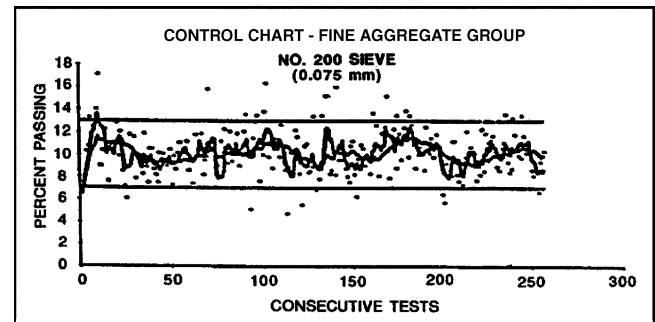
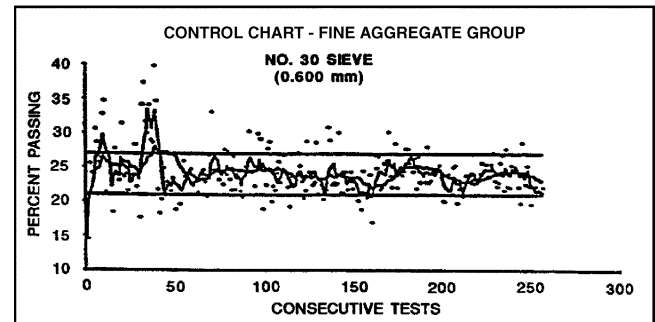
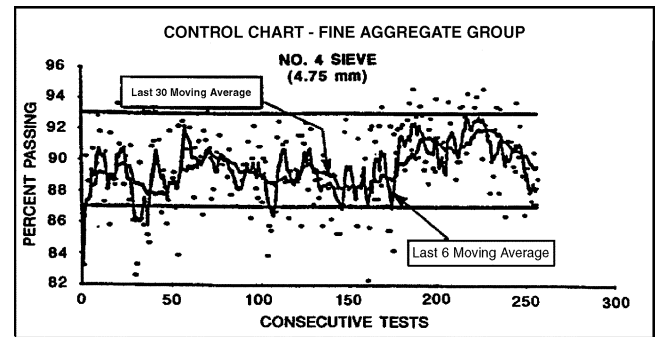

Fig. 7.6—Typical control charts for tracking fine aggregate grading results by selected individual sieves.

**7.3.4.9 Control charts**—Control charts are one of the most effective methods of tracking, displaying, and interpreting quality-control test data, and their use should be required by the project specifications. Many quality-control tests can be directly input into computers and displayed as real-time information. Nuclear density and moisture tests can be saved in most commercial gauges, and test results can be fed into a computer after each shift to give a shift moving average. Control charts should identify representative trends. A sample control chart for aggregate grading is given in Fig. 7.6. Sample control charts for RCC fresh properties are given in Fig. 7.7 and 7.8. Chapter 2 of ACI SP-2 (ACI Committee 311 1999) contains additional information on this subject.

## 7.4—Activities after RCC placement

**7.4.1 General**—Quality control after placement should include periodic inspections to ensure that the RCC is being continuously moist-cured and properly protected from damage.

**7.4.2 Curing RCC**—Quality-control records should be maintained that document the time and extent of curing, and action should be taken to correct deficiencies when observed.

**7.4.3 Protecting RCC**—Quality-control personnel should ensure that the contractor has protected the RCC surface

from freezing, drying, or precipitation. When required, RCC should be covered quickly with plastic or insulating mats to reduce evaporation or protect the surface from rain, dust, snow, and freezing temperatures. If rain is imminent or starting, inspectors should make sure that the contractor completes compaction of uncompacted RCC and immediately covers the RCC surfaces to prevent damage.

**7.4.4 Post-construction coring**—The most accurate information on in-place strength can be obtained from cores taken after completion of the project. This normally is not completed for 90 days to a year after completion of construction. The number of core tests is usually limited compared with

the normal number of cast cylinder tests made during the construction period. Carefully drilled cores also provide an indication of the lift line bonding. Post-construction coring is recommended for large projects to document the overall performance of the dam. This is useful for long-term dam safety evaluation. Concrete cores may be obtained from post-construction instrumentation holes, such as inclinometers. Typically, post-construction cores are obtained for the full depth of the dam at one or two locations or from galleries, depending on access.

**CHAPTER 8—REFERENCES**

**8.1—Referenced standards and reports**

The standards and reports listed below were the latest editions at the time this document was prepared. Because these documents are revised frequently, the reader is advised to contact the proper sponsoring group if it is desired to refer to the latest version.

*American Concrete Institute*

- 207.1R Guide to Mass Concrete
- 207.2R Report on Thermal and Volume Change Effects on Cracking of Mass Concrete
- 207.4R Cooling and Insulating Systems for Mass Concrete
- 210R Erosion of Concrete in Hydraulic Structures
- 211.1 Standard Practice for Selecting Proportions for Normal, Heavyweight, and Mass Concrete
- 211.3R Guide for Selecting Proportions for No-Slump Concrete
- 214R Guide to Evaluation of Strength Test Results of Concrete
- 304R Guide for Measuring, Mixing, Transporting, and Placing Concrete
- 325.10R Report on Roller-Compacted Concrete Pavements

*ASTM International*

- C31/C31M Standard Practice for Making and Curing Concrete Test Specimens in the Field
- C33/C33M Standard Specification for Concrete Aggregates

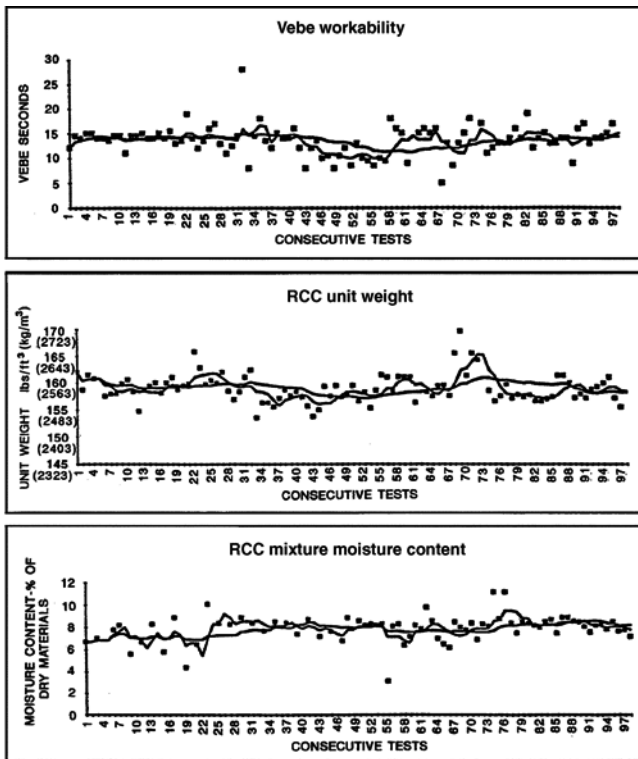

Fig. 7.7—Typical control charts for consecutive testing of Vebe, unit weight, and moisture content.

**CONTROL CHART - RCC DENSITY**

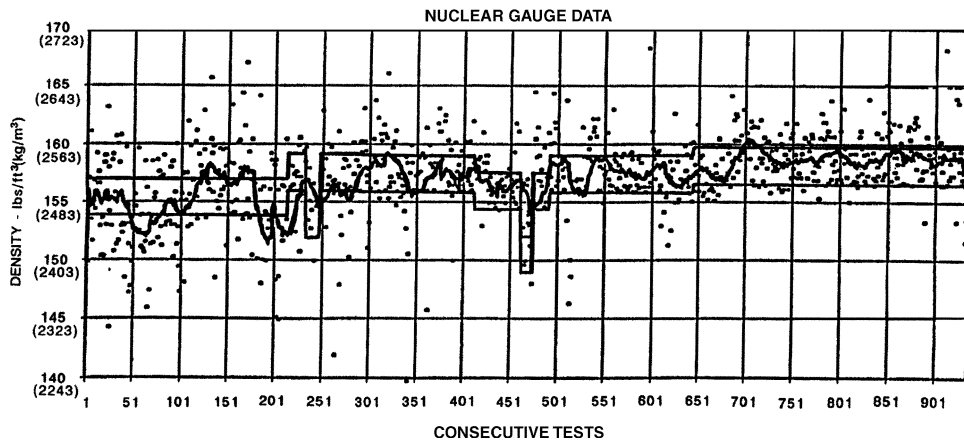

Fig. 7.8—Typical control chart for consecutive wet density test results.

C39/C39M	Standard Test Method for Compressive Strength of Cylindrical Concrete Specimens	C684	Standard Test Method for Making, Accelerated Curing, and Testing Concrete Compression Test Specimens
C42/C42M	Standard Test Method for Obtaining and Testing Drilled Cores and Sawed Beams of Concrete	C1040/C1040M	Standard Test Methods for In-Place Density of Unhardened and Hardened Concrete, Including Roller-Compacted Concrete, By Nuclear Methods
C70	Standard Test Method for Surface Moisture in Fine Aggregate	C1064/C1064M	Standard Test Method for Temperature of Freshly Mixed Hydraulic-Cement Concrete
C94/C94M	Standard Specification for Ready-Mixed Concrete	C1077	Standard Practice for Agencies Testing Concrete and Concrete Aggregates for Use in Construction and Criteria for Testing Agency Evaluation
C117	Standard Test Method for Materials Finer than 75- $\mu\text{m}$ (No. 200) Sieve in Mineral Aggregates by Washing	C1078	Test Methods for Determining the Cement Content of Freshly Mixed Concrete (withdrawn 1998)
C127	Standard Test Method for Density, Relative Density (Specific Gravity), and Absorption of Coarse Aggregate	C1079	Test Methods for Determining the Water Content of Freshly Mixed Concrete (withdrawn 1998)
C128	Standard Test Method for Density, Relative Density (Specific Gravity), and Absorption of Fine Aggregate	C1138	Standard Test Method for Abrasion Resistance of Concrete (Underwater Method)
C131	Standard Test Method for Resistance to Degradation of Small-Size Coarse Aggregate by Abrasion and Impact in the Los Angeles Machine	C1157/1157M	Standard Performance Specification for Hydraulic Cement
C136	Standard Test Method for Sieve Analysis of Fine and Coarse Aggregates	C1170/C1170M	Standard Test Method for Determining Consistency and Density of Roller-Compacted Concrete Using a Vibrating Table
C142/C142M	Standard Test Method for Clay Lumps and Friable Particles in Aggregates	C1176/C1176M	Standard Practice for Making Roller-Compacted Concrete in Cylinder Molds Using a Vibrating Table
C150/C150M	Standard Specification for Portland Cement	C1435/C1435M	Standard Practice for Molding Roller-Compacted Concrete in Cylinder Molds Using a Vibrating Hammer
C172/C172M	Standard Practice for Sampling Freshly Mixed Concrete	D75/D75M	Standard Practice for Sampling Aggregates
C231/C231M	Standard Test Method for Air Content of Freshly Mixed Concrete by the Pressure Method	D1557	Standard Test Methods for Laboratory Compaction Characteristics of Soil Using Modified Effort (56,000 ft-lbf/ft <sup>3</sup> (2,700 kN-m/m <sup>3</sup> ))
C260/C260M	Standard Specification for Air-Entraining Admixtures for Concrete	D2216	Standard Test Methods for Laboratory Determination of Water (Moisture) Content of Soil and Rock by Mass
C469/C469M	Standard Test Method for Static Modulus of Elasticity and Poisson's Ratio of Concrete in Compression	D2419	Standard Test Method for Sand Equivalent Value of Soils and Fine Aggregate
C494/C494M	Standard Specification for Chemical Admixtures for Concrete	D2940/D2940M	Standard Specification for Graded Aggregate Material for Bases or Subbases for Highways or Airports
C496/C496M	Standard Test Method for Splitting Tensile Strength of Cylindrical Concrete Specimens	D3017	Standard Test Method for Water Content of Soil and Rock in Place by Nuclear Methods (Shallow Depth) (withdrawn 2007)
C535	Standard Test Method for Resistance to Degradation of Large-Size Coarse Aggregate by Abrasion and Impact in the Los Angeles Machine	D4643	Standard Test Method for Determination of Water (Moisture) Content of Soil by the Microwave Oven Method
C566	Standard Test Method for Total Evaporable Moisture Content of Aggregate by Drying	D4791	Standard Test Method for Flat Particles, Elongated Particles, or Flat and Elongated Particles in Coarse Aggregate
C595/C595M	Standard Specification for Blended Hydraulic Cements	D4959	Standard Test Method for Determination of Water (Moisture) Content of Soil by Direct Heating
C618	Standard Specification for Coal Fly Ash and Raw or Calcined Natural Pozzolan for Use in Concrete		
C666/C666M	Standard Test Method for Resistance of Concrete to Rapid Freezing and Thawing		

- D5982 Standard Test Method for Determining Cement Content of Fresh Soil-Cement (Heat of Neutralization Method)
- E329 Standard Specification for Agencies Engaged in Construction Inspection, Special Inspection, or Testing Materials Used in Construction

*U.S. Army Corps of Engineers*

- CRD-C 55 Test Method for Within-Batch Uniformity of Freshly Mixed Concrete
- CRD-C 119 Test Method for Flat and Elongated Particles in Coarse Aggregate

These publications may be obtained from the following organizations:

American Concrete Institute  
P.O. Box 9094  
Farmington Hills, MI 48333-9094  
www.concrete.org

ASTM International  
100 Barr Harbor Drive  
West Conshohocken, PA 19428-2959  
www.astm.org

U.S. Army Engineer Research and Development Center  
3909 Halls Ferry Road  
Vicksburg, MS 39180-6199  
www.erd.usace.army.mil

## 8.2—Cited references

- Aberle, P., 2000, "Report for Grouting of Contraction Joints for Pueblo Dam," *Report to U.S. Department of the Interior, U.S. Bureau of Reclamation, Washington, DC*, June 14.
- Abrams, D., 1918, "Effect of Time of Mixing on the Strength and Wear of Concrete," *ACI JOURNAL, Proceedings* V. 14, No. 6, June, pp. 22-92.
- ACI Committee 311, 2007, *ACI Manual of Concrete Inspection, SP-2(07)*, American Concrete Institute, Farmington Hills, MI, 199 pp.
- American Concrete Institute, 2010, "ACI Concrete Terminology," American Concrete Institute, Farmington Hills, MI, <http://Terminology.concrete.org> (accessed Jan. 14, 2008).
- Andriolo, R. F., 1998, *The Use of Roller Compacted Concrete*, Oficina de Textos, Brazil.
- Arnold, T. E., and Hansen, K. D., 2002, "Seepage Performance of RCC Dams: Then and Now," 22nd Annual USSD Lecture Series, San Diego, CA, June.
- Arnold, T. E., and Johnson, D. L., 1992, "RCC Dam Design Concepts versus Construction Conditions for Stagecoach Dam," *Roller-Compacted Concrete III*, ASCE, New York, Feb., pp. 291-307.
- Arnold, T. E.; Feldsher, T. D.; and Hansen, K. D., 1992, "RCC Test Specimen Preparation—Developments toward Standard Method," *Roller-Compacted Concrete III*, ASCE, New York, pp. 341-357.
- ASCE, 1988, "Roller Compacted Concrete II," *Proceedings of the Conference Sponsored by the Construction, Geotechnical Engineering, and Materials Engineering Divisions of the American Society of Civil Engineers*, K. D. Hanson and L. K. Guice, eds., New York.
- Azari, A. M.; Peyroudin, R.; and Orteha, F., 2003, "Construction Methods for the First Large RCC Dam in Iran," *Roller Compacted Concrete Dams: Proceedings of the Fourth International Symposium on Roller Compacted Concrete Dams*, Swets & Zeitlinger, The Netherlands, pp. 905-912.
- Boggs, H. L., and Richardson, A. T., 1985, "USBR Design Considerations for Roller-Compacted Concrete Dams," *Roller-Compacted Concrete*, ASCE, New York, pp. 123-140.
- Campbell, D. B., and Johnson, P. C., 1984, "RCC Dam Incorporates Innovative Hydraulic Features," *Proceedings of the Conference on Water for Resource Development*, ASCE, Hydraulics Division, Coeur d'Alene, ID, pp. 138-142.
- Cannon, R. W., 1972, "Concrete Dam Construction Using Earth Compaction Methods," *Economical Construction of Concrete Dams*, ASCE, New York, pp. 143-152.
- Cannon, R. W., 1974, "Compaction of Mass Concrete with Vibratory Roller," *ACI JOURNAL, Proceedings* V. 71, No. 10, Oct., pp. 506-513.
- Cannon, R. W., 1993, "An Entrained Roller-Compacted Concrete," *Concrete International*, V. 15, No. 5, May, pp. 49-54.
- Chugoku Regional Construction Bureau, 1981, *Construction of Shimajigawa Dam with Roller-Compacted Dam Concrete*, Ministry of Construction, Japan.
- Clough, R. W., and Zienkiewicz, O. C., 1975, "Finite Element Methods in Analysis and Design of Dams—Part C," *Criteria and Assumptions for Numerical Analysis of Dams*, Proceedings of International Symposium, Swansea, UK, Sept.
- Croquevielle, D.; Uribe, L.; and Mutis, R., 2003, "Ralco Dam, Chile—Features of its Design and Construction," *Proceedings of the Fourth International Symposium on Roller-Compacted Concrete Dams*, Madrid, Spain, pp. 589-598.
- Crow, R.; Dolen, T.; Oliverson, J.; and Prusia, C., 1984, "Mix Design Investigation—Roller-Compacted Concrete Construction, Upper Stillwater Dam, Utah," *USBR Report REC-ERC-84-15*, June.
- Day, D. C., 2006, "Natural Weathering Exposure Station," Treat Island Programs, Engineer Research and Development Center, Geotechnical and Structures Laboratory, ([http://www.wes.army.mil/SL/TREAT\\_ISL/index.html](http://www.wes.army.mil/SL/TREAT_ISL/index.html)).
- Ditchey, E., and Schrader, E. K., 1988, "Monksville Dam Temperature Studies," *16th International Congress on Large Dams*, San Francisco, June, International Commission on Large Dams (ICOLD), V. III, Q62, pp. 379-396.
- Dolen, T. P., 1991, "Freezing and Thawing Durability of Roller Compacted Concrete," *Durability of Concrete, SP-126*, American Concrete Institute, Farmington Hills, MI, 1991, pp. 101-114.
- Dolen, T. P., 1999, "Mixture Proportioning Investigations," *Soil Cement/Roller Compacted Concrete*, Rio Salado Project, Department of the Interior, U.S. Bureau of Reclamation, Denver, CO, 6 pp.

Dolen, T. P., 2002, "Mixture Proportioning Investigations and Roller Compacted Concrete Construction, Pueblo Dam Modification," Fryingpan Arkansas Project, *Report No. MERL-2002-02*, U.S. Department of the Interior, U.S. Bureau of Reclamation, Denver, CO, 8 pp.

Dolen, T. P., 2003, "Long-Term Performance of Roller Compacted Concrete at Upper Stillwater Dam, Utah," *Proceedings of the International Symposium on Roller Compacted Concrete Dams*, Swets & Zeitlinger, The Netherlands, pp. 1117-1126.

Dolen, T. P., and Tayabji, S. D., 1988, "Bond Strength of Roller-Compacted Concrete," *Roller-Compacted Concrete II*, ASCE, New York, Feb., pp. 170-186.

Dolen, T. P.; Richardson, A. T.; and White, W. R., 1988, "Quality Control/Inspection—Upper Stillwater Dam," *Roller-Compacted Concrete II*, ASCE, New York, Feb., pp. 277-293.

Dunstan, M. R. H., 1978, "Rolled Concrete—With Particular Reference to Its Use as Heating Material in Concrete Dams," The Concrete Society, London, UK, Mar.

Dunstan, M. R. H., 1981a, "Rolled Concrete for Dams—Laboratory Study of Properties of High Fly Ash Content Concrete," *CIRIA Technical Note 105*, London, UK, May, 96 pp.

Dunstan, M. R. H., 1981b, "Rolled Concrete for Dams—Construction Trials Using High Fly Ash Content Concrete," *CIRIA Technical Note 106*, London, UK, May, 94 pp.

Dunstan, M. R. H., 1985, "A Method of Design for Mix Proportions of Roller-Compacted Concrete to be Used in Dams," *Transactions*, V. 2, 15th International Congress on Large Dams, International Commission on Large Dams (ICOLD), Paris, pp. 713-738.

Dunstan, M. R. H.; Dolen, T. P.; Ibanez-de-Aldecoa, R.; and Erharz, J. L., 2003, "Successful Large RCC Dams—What Are the Common Features?" Internal RCC Symposium, Swets & Zeitlinger, The Netherlands, pp. 127-138.

Electric Power Research Institute (EPRI), 1986, "Roller-Compacted Concrete for Dams," *Report AP-4715*, Palo Alto, CA, Sept.

*Engineering News Record*, 1964, "Concrete Gravity Dam Built Like Earthfill," V. 173, Dec. 24, 32 pp.

*Engineering News Record*, 1986, "RCC Dam Survives Texas Flood," Apr. 27.

Forbes, B. A., 1985, "Roller-Compacted Concrete Design, Construction, and Performance of Copperfield Dam," Institution of Engineers Australia (Queensland Division), Brisbane, Sept.-Oct.

Forbes, B. A., 1999, "Grout Enriched RCC: A History and Future," *International Water Power and Dam Construction*, Wilmington Business Publishing, Kent, UK, June, pp. 34-38.

Forbes, B. A., 2008, "RCC—New Developments and Innovations," IBRACON 1st Brazilian International RCC Symposium, Salvador, Brazil.

Forbes, B. A.; Yang, L.; Tang, G.; and Yang, K., 1999, "Some Interesting Techniques Developed for High Quality RCC Construction," *Proceedings of the Internal Symposium on Roller Compacted Concrete Construction*, Apr.

Gaekel, L., and Schrader, E. K., 1992, "RCC Mixes and Properties Using Poor Quality Materials—Concepcion Dam," *Roller-Compacted Concrete III*, ASCE, New York.

Gentile, G., 1964, "Study, Preparation, and Placement of Low Cement Concrete, with Special Regard to its Use in Solid Gravity Dams," *Transactions*, International Congress on Large Dams, International Commission on Large Dams (ICOLD), Paris, France.

Giovagnoli, M.; Schrader, E.; and Ercoli, F., 1991, "Design and Construction of Concepcion Dam," *Proceedings*, International Symposium on RCC Dams, Nov.

Hall, D. J., and Houghton, D. L., 1974, "Roller-Compacted Concrete Studies at Lost Creek Dam," U.S. Army Engineer District, Portland, OR, June.

Hansen, K. D., 1992, "RCC for Rehabilitation of Dams in USA—An Overview," *Roller-Compacted Concrete III*, ASCE, New York, Feb., pp. 22-46.

Hansen, K. D., 2001, "The Many Faces of RCC," *Civil Engineering*, ASCE, V. 71, No. 4, Apr., pp. 48-53.

Hansen, K. D., and Reinhardt, W. G., 1991, *Roller-Compacted Concrete Dams*, McGraw Hill, New York.

Harris, D. W.; Mohorovic, C. E.; and Dolen, T. P., 2000, "Dynamic Properties of Mass Concrete Obtained from Dam Cores," *ACI Materials Journal*, V. 97, No. 3, May-June, pp. 290-296.

Hirose, T., and Yanagida, T., 1981, "Some Experiences Gained in Construction of Shimajigawa and Okawa Dams," *Proceedings*, CIRIA Conference on Rolled Concrete for Dams, Construction Industry Research and Information Association, London, UK, June.

Hollingworth, F.; Druyts, F. H. W. H.; and Maartens, W. W., 1988, "Some South African Experiences in Design and Construction of Rollcrete Dams," *16th International Congress on Large Dams*, V. III, International Commission on Large Dams (ICOLD), pp. 33-51.

Hopman, D. R., 1992, "Lessons Learned from Elk Creek Dam," *Roller-Compacted Concrete III*, ASCE, New York, Feb., pp. 162-180.

Hopman, D. R., and Chambers, D. R., 1988, "Construction of Elk Creek Dam," *Roller-Compacted Concrete II*, ASCE, New York, Feb., pp. 251-266.

Humphreys, T. D.; Jardine, F. M.; and Nash, J. K., 1965, "The Economic and Physical Feasibility of Soil-Cement Dams," *6th International Conference on Soil Mechanics and Foundation Engineering*, V. II, Canada.

Jansen, R. B., 1989, *Advanced Dam Engineering for Design, Construction, and Rehabilitation*, Van Nostrand Reinhold, New York.

Johnson, H. A., and Chao, P. C., 1979, "Rollcrete Usage at Tarbela Dam," *Concrete International*, V. 1, No. 11, Nov., pp. 20-33.

Lindvall, Richter, and Associates, 1975, *Final Report for Investigation and Reanalysis of Big Tujunga Dam*, V. 2, Los Angeles, CA, Oct.

Londe, P., and Lino, M., 1992, "The Faced Symmetrical Hard Fill Dam: A New Concept for RCC," *Water Power and Dam Construction*, Feb.

- Marulanda, A.; Amaya, F.; and Schrader E., 1992, "Design of Meil II—A High RCC Dam," *Proceedings of ASCE Roller Compacted Concrete III*, San Diego, CA, pp. 83-98.
- Marulanda, A.; Rubiano, N. R.; and Castro, A., 2003, "Construction Issues of Meil I Dam, The World's Tallest RCC Dam," *Internal RCC Symposium*, Madrid, Spain, pp. 333-343.
- McDonald, J. E., 2002, "Grout Enriched Roller-Compacted Concrete—Phase I Investigation," U.S. Army Engineer Research and Development Center (CEERD-GM-R), Vicksburg, MS. [http://www.wes.army.mil/SL/HPMS/HPMS\\_art-3.pdf](http://www.wes.army.mil/SL/HPMS/HPMS_art-3.pdf) (accessed March 2, 2008)
- McDonald, J. E., and Curtis, N. F., 1997, "Applications of Roller-Compacted Concrete in Rehabilitation and Replacement of Hydraulic Structures," *Technical Report REMR-CS-53*, U.S. Army Engineer Waterways Experiment Station, Vicksburg, MS, 184 pp.
- McLean, F. G., and Pierce, J. S., 1988, "Comparison of Joint Strengths for Conventional and Roller-Compacted Concrete," *Roller-Compacted Concrete II*, ASCE, New York, Feb., pp. 151-169.
- McTavish, R. F., 1988, "Construction of Upper Stillwater Dam," *Roller-Compacted Concrete II*, ASCE, New York, Feb., pp. 267-276.
- MDA & Associates, "RCC Dams Database," Devon, UK, 2003.
- Ministry of Construction, 1984, "Development in Japan of Concrete Dam Construction by RCD Method," Tokyo, Japan.
- Moreno, G., 2003, "Challenges in Ralco Dam Construction," *Proceedings of the Fourth International Symposium on Roller Compacted Concrete Dams*, Madrid, Spain, pp. 1005-1011.
- Oliverson, J. E., and Richardson, A. T., 1984, "Upper Stillwater Dam—Design and Construction Concepts," *Concrete International*, V. 6, No. 5, May, pp. 20-28.
- Omeregic, F. A.; Gutschow, R. A.; and Russell, M. L., 1994, "Cement-Hardened Materials for Abrasion-Erosion in Hydraulic Structures," *Concrete International*, V. 16, No. 7, July, pp. 47-50.
- Parent, W. F.; Moler, W. A.; and Southard, R. W., 1985, "Construction of Middle Fork Dam," *Roller-Compacted Concrete*, ASCE, New York, pp. 71-89.
- Pauletto, M.; Dunstan, M. R. H.; and Ortega, F., 2003, "Trial Mix Programme and Full-Scale Trials for Olivenhain RCC Dam, USA," *Proceedings of the Fourth International Symposium on Roller Compacted Concrete Dams*, Madrid, Spain, pp. 329-338.
- Portland Cement Association, 2002, "RCC for Safe Dams Resource Notebook," SP-387, PCA, Skokie, IL.
- Raphael, J. M., 1971, "The Optimum Gravity Dam," *Rapid Construction of Concrete Dams*, ASCE, New York, pp. 221-247.
- Raphael, J. M., 1984, "Tensile Strength of Concrete," *ACI JOURNAL*, *Proceedings* V. 81, No. 2, Mar.-Apr., pp. 158-165.
- Reed, G. E.; Rogers, M. F.; and Ehasz, J. L., 2003, "Building the Olivenhain," *Civil Engineering*, Apr., pp. 46-53.
- Reeves, G. N., and Yates, L. B., 1985, "Simplified Design and Construction Control for Roller-Compacted Concrete," *Roller-Compacted Concrete*, New York, pp. 48-61.
- Schrader, E. K., 1982, "The First Concrete Gravity Dam Designed and Built for Roller-Compacted Construction Methods," *Concrete International*, V. 5, No. 10, Oct., pp. 16-24.
- Schrader, E. K., 1985, "Watertightness and Seepage Control in Roller-Compacted Concrete Dams," *Roller-Compacted Concrete*, ASCE, New York, May, pp. 11-30.
- Schrader, E. K., 1987a, "Design for Strength Variability: Testing and Effects on Cracking in RCC and Conventional Concretes," *Lewis Tuthill Symposium on Concrete and Concrete Construction*, SP-104, G. T. Halvorsen, ed., American Concrete Institute, Farmington Hills, MI, pp. 1-25.
- Schrader, E. K., 1987b, "Compaction of Roller-Compacted Concrete," *Consolidation of Concrete*, SP-96, S. H. Gebler, ed., American Concrete Institute, Farmington Hills, MI, pp. 77-101.
- Schrader, E. K., 1993, "Design and Facing Options for RCC on Various Foundations," *Water Power & Dam Construction*, Sutton, Surrey, UK, Feb.
- Schrader, E. K., 1994, "Roller-Compacted Concrete for Dams, State of the Art," *International Conference on Advances in Concrete Technology*, second edition, CANMET, Ottawa, ON, Canada.
- Schrader, E. K., 1999, "Shear Strength and Lift Joint Quality of RCC," *Hydropower & Dams*, Issue 1, pp. 46-55.
- Schrader, E. K., 2002, "A Few Interesting RCC Dams," *Roller Compacted Concrete for Dams and Dam Rehabilitation*, Proceedings, Portland Cement Association Symposium, San Diego, CA, Aug. 26-27.
- Schrader, E. K., 2006a, "Building Roller-Compacted Concrete Dams on Unique Foundations," *HRW*, HCI Publications, Mar., pp. 28-33.
- Schrader, E. K., 2006b, "Building Roller-Compacted-Concrete Dams on Difficult Foundations: Practical Examples," *HRW*, HCI Publications, May, pp. 1-10.
- Schrader, E. K., and Balli, J. A., 2003, "Rompepicos Dam at Corral des Palmas with Final Design During Construction," *Roller Compacted Concrete Dams*, International RCC Dam Symposium, Madrid, Spain, Nov.
- Schrader, E. K., and McKinnon, R., 1984, "Construction of Willow Creek Dam," *Concrete International*, V. 6, No. 5, May, pp. 38-45.
- Schrader, E. K., and Namikas, D., 1988, "Performance of Roller-Compacted Concrete Dams," *16th International Congress on Large Dams*, San Francisco, June, International Commission on Large Dams (ICOLD), V. III, Q62, pp. 339-364.
- Schrader, E. K., and Rashed, A., 2002, "Benefits of Non-Linear Stress-Strain Properties and Membranes for RCC Dam Stresses," International Conference on RCC Dam Construction in Middle East, pp. 331-344.
- Schrader, E. K., and Rizzo, P. C., 2003, "Extensive Shear Testing for Saluda Dam Roller Compacted Concrete," *Roller Compacted Concrete Dams*, International RCC Dam Symposium, Madrid, Spain, pp. 1045-1056.



Schrader, E. K., and Stefanakos, J., 1995, "RCC Cavitation and Erosion Resistance," *Proceedings of the International Symposium on Roller Compacted Concrete*, pp. 1175-1188.

Schrader, E. K., and Thayer, H. J., 1982, "Willow Creek Dam—A Roller-Compacted Concrete Fill," *Transactions*, V. 4, 14th International Congress on Large Dams, Rio de Janeiro, International Commission on Large Dams (ICOLD), Paris, pp. 453-479.

Sexton, D. L.; Hurt R. L.; and Lewis, R. G., "RCC Dam Construction and Method," United States Patent and Trademark Office, Washington, DC. <http://patimg1.uspto.gov/piw?Docid=4659252&idkey=NONE> (accessed Dec. 9, 2010)

Shelke, V. C.; Dunstan, M. R. H.; Hinks, J. L.; and Zelenka, T., 2006, "Construction of Three RCC Dams Forming Part of the Ghatghar Pumped Storage Project in India," *Improvements in Reservoir Construction, Operations and Maintenance*, 14th Conference of the British Dam Society, University of Durham, pp. 406-411.

Sivley, W. E., 1976, "Zintel Canyon Optimum Gravity Dam," *Transactions*, V. 5, 12th International Congress on Large Dams, pp. 141-145.

Soroushian, P.; Choi, K.-B.; and Abdulazig, A., 1986, "Dynamic Constitutive Behavior of Concrete," *ACI JOURNAL, Proceedings* V. 83, No. 2, Mar.-Apr., pp. 251-259.

Tarbox, G. S., and Hansen, K. D., 1988, "Planning, Design, and Cost Estimates for RCC Dams," *Roller-Compacted Concrete II*, ASCE, New York, Feb., pp. 21-38.

Tatro, S. B., 1999, "Commentary on the Corps of Engineers Approach to Thermal Analysis of RCC Structures," *Proceedings of the International Symposium on Roller Compacted Concrete Dam*, Chinese Society for Hydroelectric Engineering, Chengdu, China.

Tatro, S. B., and Schrader, E. K., 1985, "Thermal Considerations for Roller-Compacted Concrete," *ACI JOURNAL, Proceedings* V. 82, No. 2, Mar.-Apr., pp. 119-128.

Tatro, S. B., and Hinds, J. L., 1992, "Roller-Compacted Concrete Mix Design," *Roller-Compacted Concrete III*, ASCE, New York, pp. 323-340.

Tatro, S. B., and Schrader, E. K., 1992, "Thermal Analysis for RCC—A Practical Approach," *Roller-Compacted Concrete III*, ASCE, New York, pp. 389-406.

Tayabji, S. D., and Okamoto, A. S., 1987, "Bonding of Successive Layers of Roller-Compacted Concrete," Construction Technology Laboratories, Skokie, IL.

Technical Center for National Land Development, 1981, "Technical Guide to RCD Construction Method," Japan, July.

Tynes, W. O., 1973, "Feasibility Study of No-Slump Concrete for Mass Concrete Construction," *Miscellaneous Paper* No. C-73-10, U.S. Army Corps of Engineers, Waterways Experiment Station, Vicksburg, MS, Oct., 29 pp.

United States Society on Dams, 2003, "RCC Construction for Dam Rehabilitation," Denver, CO.

USACE, 1984, "Willow Creek Dam Concrete Report," V. 1 and 2, U.S. Army Corps of Engineers, Walla Walla, WA.

USACE, 1993, "Structural Design Using the Roller-Compacted Concrete (RCC) Construction Process," ETL 1110-2-343, U.S. Army Corps of Engineers, Washington, DC, 25 pp.

USACE, 1994a, "Nonlinear, Incremental Structural Analysis of Massive Concrete Structures," ETL 1110-2-265, U.S. Army Corps of Engineers, Washington, DC, 75 pp.

USACE, 1994b, "Standard Practice for Concrete for Civil Works Structures," EM 1110-2-2000, U.S. Army Corps of Engineers, Washington, DC, 124 pp.

USACE, 1995a, "Gravity Dam Design," EM No. 1110-2-2200, U.S. Army Corps of Engineers, Washington, DC, 88 pp.

USACE, 1995b, "Seismic Design Provisions for Roller Compacted Concrete Dams," EP 1110-2-12, Washington, DC, 117 pp.

USACE, 1995c, "Earthquake Design and Analysis for Corps of Engineers Projects," ER 1110-2-1806, Washington, DC, 25 pp.

USACE, 1997, "Thermal Studies of Mass Concrete Structures," ETL 1110-2-542, U.S. Army Corps of Engineers, Washington, DC, 75 pp.

USACE, 2003, "Structural Design and Evaluation of Outlet Works," EM 1110-2-2400, Washington, DC, 143 pp.

USACE, 2006, "Roller-Compacted Concrete," EM 1110-2-2006, U.S. Army Corps of Engineers, Washington, DC, 77 pp.

U.S. Bureau of Reclamation, 1976, "Design of Gravity Dams," Denver, CO, 553 pp.

U.S. Bureau of Reclamation, 1977a, "Design Criteria for Concrete Arch and Gravity Dams," *Engineering Monograph* No. 19, Feb.

U.S. Bureau of Reclamation, 1977b, "Laboratory Testing Program to Evaluate Physical Properties of Auburn Dam Design Concrete Mix for Rapid Strain Rates—Central Valley Project, California," Memorandum from Chief, Dam Branch to Chief, Concrete and Structural Branch, Denver, CO, Aug. 29.

U.S. Bureau of Reclamation, 1978, "Design and Analysis of Auburn Dam," *Dynamic Studies*, V. 4, Denver, CO, Apr.

U.S. Bureau of Reclamation, 1987, "Guidelines for Designing and Constructing Roller-Compacted Concrete Dams," *ACER Technical Memorandum* No. 8, Denver, CO.

U.S. Bureau of Reclamation, 1992, "Concrete Construction Data, Camp Dyer Diversion Dam Modification," Feb.

U.S. Bureau of Reclamation, 2005, "Roller-Compacted Concrete, Design and Construction Considerations for Hydraulic Structures," Technical Service Center, Denver, CO, pp. 14-15.

U.S. Committee on Large Dams, 1994, "Annotated Bibliography on Roller-Compacted Concrete Dams," Denver, CO, June.

Wallingford, V. M., 1970, "Proposed New Technique for Construction of Concrete Gravity Dams," *Transactions*, V. 4, 10th International Congress on Large Dams, Montreal, QC, Canada, International Commission on Large Dams (ICOLD), Paris, pp. 439-452.

Warren, E., 2009, "Building an RCC Dam in the Jordan Valley," *International Water Power and Dam Construction*, Global Trade Media, UK, Aug.

Wenquan, L.; Huizhen, L.; Zhen, H.; and Yajie, L., 1997, "Use of High-Range Retarder-Plasticizer for Roller-Compacted Concrete of the Three Gorges Project in China," *Superplasticizers and Other Chemical Admixtures in Concrete*, SP-173, V. M. Malhotra, ed., American Concrete Institute, Farmington Hills, MI, pp. 835-854.



American Concrete Institute®  
*Advancing concrete knowledge*

As ACI begins its second century of advancing concrete knowledge, its original chartered purpose remains “to provide a comradeship in finding the best ways to do concrete work of all kinds and in spreading knowledge.” In keeping with this purpose, ACI supports the following activities:

- Technical committees that produce consensus reports, guides, specifications, and codes.
- Spring and fall conventions to facilitate the work of its committees.
- Educational seminars that disseminate reliable information on concrete.
- Certification programs for personnel employed within the concrete industry.
- Student programs such as scholarships, internships, and competitions.
- Sponsoring and co-sponsoring international conferences and symposia.
- Formal coordination with several international concrete related societies.
- Periodicals: the *ACI Structural Journal* and the *ACI Materials Journal*, and *Concrete International*.

Benefits of membership include a subscription to *Concrete International* and to an ACI Journal. ACI members receive discounts of up to 40% on all ACI products and services, including documents, seminars and convention registration fees.

As a member of ACI, you join thousands of practitioners and professionals worldwide who share a commitment to maintain the highest industry standards for concrete technology, construction, and practices. In addition, ACI chapters provide opportunities for interaction of professionals and practitioners at a local level.

**American Concrete Institute**  
**38800 Country Club Drive**  
**Farmington Hills, MI 48331**  
**U.S.A.**

**Phone: 248-848-3700**

**Fax: 248-848-3701**

**[www.concrete.org](http://www.concrete.org)**

# Report on Roller-Compacted Mass Concrete

## The AMERICAN CONCRETE INSTITUTE

was founded in 1904 as a nonprofit membership organization dedicated to public service and representing the user interest in the field of concrete. ACI gathers and distributes information on the improvement of design, construction and maintenance of concrete products and structures. The work of ACI is conducted by individual ACI members and through volunteer committees composed of both members and non-members.

The committees, as well as ACI as a whole, operate under a consensus format, which assures all participants the right to have their views considered. Committee activities include the development of building codes and specifications; analysis of research and development results; presentation of construction and repair techniques; and education.

Individuals interested in the activities of ACI are encouraged to become a member. There are no educational or employment requirements. ACI's membership is composed of engineers, architects, scientists, contractors, educators, and representatives from a variety of companies and organizations.

Members are encouraged to participate in committee activities that relate to their specific areas of interest. For more information, contact ACI.

**[www.concrete.org](http://www.concrete.org)**



**American Concrete Institute®**  
*Advancing concrete knowledge*